

Process Instrumentation Valve and Manifold Solutions

H Series Product Range



ENGINEERING YOUR SUCCESS.

Contents

Introduction	5
General Technical Information	6
Design	6
Materials of construction.....	6
Standard and optional specification details.....	7
Connections	8
Integral tubing connections – A Parker Superior Advantage.....	8
PTFree connect™.....	10
Other connections.....	11
Transmitter flange connections - DIN/IEC 61518	12
Bonnet Assemblies	13
Standard bonnet design.....	13
Larger bore bonnet design - Class 2500 (6,000 PSI) and Class 4500 (10,000 PSI).....	14
Soft seat tip bonnet design.....	14
Fire safe bonnet design - Class 2500 (6,000 PSI).....	15
Power plant bonnet design - Compliant to ANSI B31.1 – Class 2500 (6,000 PSI).....	15
Rising plug bonnet design	16
Tru-Loc® safety bonnet lock.....	16
Low Emission bonnet design.....	17
Bonnet assembly options	19
Hand Valves & Gauge Valves	20
Introduction.....	20
Hand Valves - HNV Series - Straight Pattern	21
Hand Valves - HNAV Series - Angle Pattern	22
Gauge Valves - HNVV Series - Single Block Gauge Vent Valves	23
Gauge Valves - HGV Series - Multi-port Gauge Valves	24
Rising Plug Valves - HRPV Series.....	25
Ordering information.....	26
2-Valve Manifolds - Remote/line Mount	28
Introduction.....	28
2-Valve Manifolds - HNL Series - Remote/line Mount - Long Pattern.....	29
2-Valve Manifolds - Remote/line Mount - Short Pattern.....	30
Ordering Information - 2-Valve Manifolds - Remote/Line Mount	32
Mounting Brackets for Remote/line Mount Manifolds and Gauge Valves.....	34
3 and 5-Valve Manifolds - Remote/line Mount	35
Introduction.....	35
3-Valve Manifolds - Remote/line Mount	36
5-Valve Manifolds - Remote/line Mount	37
Ordering Information - 3 and 5-valve Manifolds - Remote/line Mount	38
Mounting Brackets for Remote/line Mount Manifolds and Gauge Valves.....	40
2-Valve Manifolds - Direct Mount	41
3-Valve Manifolds - Direct Mount	42
5-Valve Manifolds - Direct Mount	44
Ordering information.....	46
Mounting Brackets for 2, 3 and 5-valve Direct Mount Manifolds.....	48
Base Connected Manifolds Especially Suited For Enclosure Mounting	50
Instrument Enclosure Solutions	54
Manifolds for 2051/3051 Coplanar™ Transmitters	55
Essential Manifold Accessories	61
Other Manifold Products	64
Customer Specific Manifold Solutions	66
Complementary Products for Complete Installation Solutions	68

PROCESS INSTRUMENTATION VALVE AND MANIFOLD SOLUTIONS

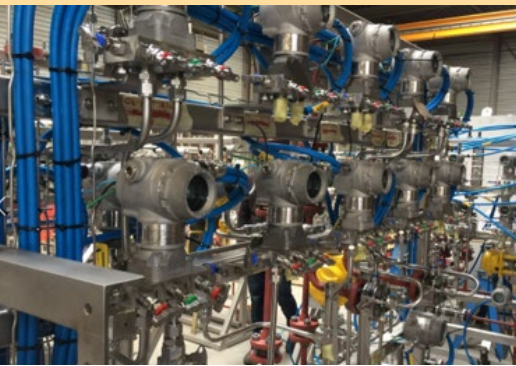

Introduction

Welcome to the Parker Superior Advantage for your process to instrument hook ups.

Wholly designed and manufactured from decades of development, experience and knowledge from within our ISO 9000 compliant UK facility, the Parker H-series valve and manifold solutions range enjoys world leading recognition for quality, reliability and value.

Selection can be made from a comprehensive range of bonnet assemblies, body configurations and styles with a variety of connections and material options to suit all your applications, optimising your installation and improving operation.

In addition to producing these valves and manifolds with your choice of connections, all the products offered in this catalogue are available (as standard) with the superior advantage of integrated tubing connections. The specification of the world renowned and universally acceptable Parker compression type connections will improve system performance, increase safety, reduce size and weight and simplify installation which ultimately reduces overall user costs.

The top five target markets for Parker Instrumentation are shown below, but Parker manifold solutions are suitable for the widest range of process measurement and control applications in a diverse spectrum of industries.

Continuous product development may from time to time necessitate changes in the details contained in this catalogue. Parker reserves the right to make such changes at their discretion and without prior notice.

All dimensions shown in this catalogue are approximate and subject to change.

Every effort is made to provide sufficient, clear and accurate information to allow the correct selection of product from this catalogue, but ultimately it is the system designer's or user's responsibility to ensure selected product is suitable for the intended application. Should you require further information please do not hesitate to contact your local Parker support.

With thousands of distributor outlets and stores worldwide, and hundreds of Parker personnel and locations, Parker also offers the superior advantage of supply and support in your locale.



Upstream Oil & Gas



Downstream Oil & Gas

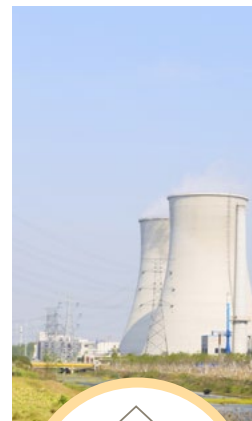

PowerGen



Industrial Gas

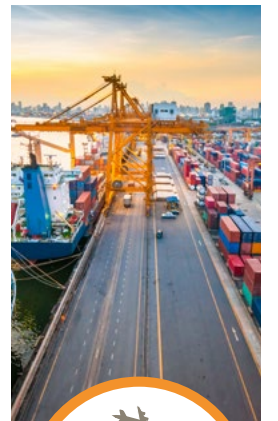

Transportation

Parker EHS Vision Statement:

Parker recognizes, and believes, in the importance of safeguarding natural resources and the global environment. We are committed to our employees, our communities, and our customers: their health, safety and understanding of the need for environmental stewardship.

We are committed to the concept of continuous improvement in environmental performance. Accordingly, we are committed to the following principles:

- We will seek to comply with environmental, health, and safety laws worldwide.
- We strive to minimize or eliminate the generation of waste.
- We will monitor compliance with environmental, health and safety regulations.

General Technical Information

Design

All valves and manifolds are designed to meet the pressure and temperature ratings of ANSI B16.34 Class 2500/Class 4500 as applicable, limited only by selection of gland packing materials. Conformity to the recommendations of MSS SP-99 is also assured.

Relevant codes, standards and specifications

Code/Specification	Description
DIN EN61518 / IEC 61518	Mating dimensions between differential pressure (type) measuring instruments
ASME B31.1	Power Piping Specification for Pipeline Valves
ASME B16.34	Valves - Flanged, Threaded and Welding End
ASME B16.5	Pipe Flanges and Flanged Fittings
NACE MR0175 / ISO 15156	Petroleum and Natural Gas Industries - Materials for use in H2S - containing Environments in Oil and Gas Production
API 598	Valves Inspection and Testing
ISO 5208	Industrial Valves - Pressure Testing of Metallic Valves
API 607 / ISO 10497	Fire Test of Soft-Seated Quarter Turn Valves Fire type-testing requirements
MSS SP-25	Standard Marking Systems for Valves, Fittings, Flange and Unions
MSS SP-61	Pressure Testing of Valves
MSS SP-99	Instrument Valves
ISO 15848	Industrial valves— Measurement, test and qualification procedures for fugitive emissions
TA Luft	TA-Luft 2002, Absatz 5.2.6.4 und VDI 2440 (Ausgabe Nov. 2000), Absatz 3.3.1.3

Materials of construction

All materials are purchased from long standing reputable sources, conforming not only to recognised national/international standards, but also to additional requirements imposed by Parker to assure suitability/usability across the widest spectrum of user applications.

A range of techniques and processes including PMI (Positive Material Identification) are used to validate all incoming material supplies, segregation, storage and maintenance of product quality.

Body material options

Material Group	Material Designator	UNS No.	Werkst-off No.	Euronorm Equivalent	ASTM Material Grade
Carbon Steel*	A105	UNS 1.0482	19Mn5	K03504	A105
Austenitic Stainless Steel	316/316L Dual certified	UNS S31600	1.4401	X5CrNiMo17-12-2	A479 Gr 316
		UNS S31603	1.4404	X2CrNiMo17-12-2	A479 Gr 316L
Super Austenitic Stainless Steel	6Mo	UNS S31254	1.4547	X1CrNiMoCuN20-18-7	A479/A276
Austenitic-Ferritic Steel (Duplexes)	Duplex 22Cr	UNS S31803	1.4462	X2CrNiMoN22 5 3	A479/A276
		UNS S32750	1.4410	X2CrNiMoN25-7-4	A479/A276
		UNS S32760	1.4501	X2CrNiMoCuWN25-7-4	A479/A276
Copper-Nickel Alloy	Alloy M400	UNS N04400	2.436	NiCu30Fe	ASTM B164
Nickel Alloy	Alloy 825	UNS N08825	2.4858	NiCr21Mo	ASTM B425
Nickel Alloy	Alloy 625	UNS N06625	2.4856	NiCr22Mo9Nb	ASTM B446
Nickel Alloy	Alloy C276	UNS N10276	2.4819	NiMo16Cr15W	ASTM B574
Titanium	TitaniumGrade 2	UNS R50400	3.7075	Ti-II	ASTM B348

All materials will meet (as applicable) the requirements of NACE MR0103/MR0175 and ISO 15156. They are further supplied as per NORSOK M650/M630 as required.

* Carbon Steel may not be universally available, and if offered, may be restricted to body only. Other materials may be considered but any offer may also be restricted to body only. Please consult with your local Parker support.

General information - materials of construction

Item	Material								
	St.St.	CRA-NiCu	Duplex	Super Duplex	CRA-NiMoCr	Titanium	6MO	Alloy 825	Alloy 625
Body	316 St.St. ASTM A479	Alloy M400	Duplex UNS 31803	Super Duplex UNS S32750/32760	Alloy C276	Titanium GR-2	6MO	Alloy 825	Alloy 625
Tip	17-4PH St.St.	Alloy K500	Duplex UNS S.32750/32760	Alloy 625	Alloy B3	Titanium GR-5	DUPLEX UNS S.32750/32760	Alloy 625	Alloy 718
Joint Seal	316 St.St. ASTM A479	Alloy M400	6MO	Alloy 625	Alloy C276	Alloy 825	6MO	Alloy 825	Alloy 625
Packing	P.T.F.E. / Graphite	P.T.F.E. / Graphite	P.T.F.E. / Graphite	P.T.F.E. / Graphite	P.T.F.E. / Graphite	P.T.F.E. / Graphite	P.T.F.E. / Graphite	P.T.F.E. / Graphite	P.T.F.E. / Graphite
Thrust Bush	316 St.St.	316 St.St.	316 St.St.	316 St.St.	316 St.St.	316 St.St.	316 St.St.	316 St.St.	316 St.St.
Stem	316 St.St. ASTM A479	Alloy M400	Duplex UNS 31803	Super Duplex UNS S32750/32760	Alloy C276	Titanium GR-2	6MO	Alloy 825	Alloy 625
Gland Adjuster	316 St.St. ASTM A479	316 St.St. ASTM A479	316 St.St. ASTM A479	316 St.St. ASTM A479	316 St.St. ASTM A479	316 St.St. ASTM A479	316 St.St. ASTM A479	316 St.St. ASTM A479	316 St.St. ASTM A479
Handle	316 St.St.	316 St.St.	316 St.St.	316 St.St.	316 St.St.	316 St.St.	316 St.St.	316 St.St.	316 St.St.
Grub Screw	A4-80 St.St.	A4-80 St.St.	A4-80 St.St.	A4-80 St.St.	A4-80 St.St.	A4-80 St.St.	A4-80 St.St.	A4-80 St.St.	A4-80 St.St.
Dust Cap	LDPE - Coloured	LDPE - Coloured	LDPE - Coloured	LDPE - Coloured	LDPE - Coloured	LDPE - Coloured	LDPE - Coloured	LDPE - Coloured	LDPE - Coloured
Lock Nut	316 St.St.	316 St.St.	316 St.St.	316 St.St.	316 St.St.	316 St.St.	316 St.St.	316 St.St.	316 St.St.
Bonnet	316 St.St. ASTM A479	Alloy M400	Duplex UNS 31803	Super Duplex UNS S32750/32760	Alloy C276	Titanium GR-2	6MO	Alloy 825	Alloy 625

Max. Working Pressure	6,000 psig (414 barg)
High Pressure Range	10,000 psig (689 barg)
Temperature Range:	
• P.T.F.E. Packing	-54°C to 260°C (-65°F to 500°F)
• Graphite Packing	-54°C to 538°C (-65°F to 1000°F)

Notes:

- CRA-NiCu selection down-rates to 5,000 psig (345 barg)
- Titanium selection down-rates to 3,950 psig (272 barg)
- Other materials and option selections can also affect performance ratings. If in doubt, please consult your local Parker support.

Standard and optional specification details

Standard Specification Details	Optional Specification Details
Seat orifice diameter: 4mm	Seat orifice diameter: up to 6mm in some configurations/styles. See page 14
Flow co-efficient (Cv): 0.35	6mm - Flow co-efficient (Cv): 0.5
Metal to metal valve seat and stem tip	Alternative soft tip and tip materials. See page 14
100% pressure test. All valves and manifolds are subjected to hydrostatic pressure at 1.1x maximum working pressure for the seat and 1.5x maximum working pressure for the shell	Alternative pressure test regimes applied to oxygen cleaned and/or low emission products. See page 17 Your other pressure test requirements can be considered
All products supplied in a clean bur and grease free condition suitable for most liquid and gaseous applications	Cleaned suitable for oxygen service. Not every product option is suitable for oxygen service
Bodies and bonnets are fully traceable to original material source (certification with unique trace code applied to the bar stock material)	Alternative levels of traceability and certification are available. Your other requirements can be considered
Certification according to BS EN 10204 3.1 for material and pressure test is available	Certification according to BS EN 10204 3.2 can be available at additional cost, please contact your local Parker support
All products are permanently marked. Manifolds include a line diagram describing the flow paths	
Complementary to the marking, bonnet assemblies are all functionally colour coded by the dust caps	
Number of turns open to close: 3.5	6mm - Number of turns open to close: 3.3
Gauge valves and manifolds do not include plugs as standard	Various plugs are available to order. See page 61
Direct mount manifolds include applicable flange face seals and high tensile, zinc plated carbon steel mounting bolts	Stainless steel mounting bolts are available. See page 48
All manifolds include mounting holes suitable for brackets or enclosure mounting	A full range of mounting brackets and accessories are available. See pages 40, 48, 60 Mounting for selected hand valves and gauge valves is available

Connections

Introduction

Parker valve and manifold products are available with a wide array of connection types and sizes. These products are manufactured at the highest quality to applicable standards, utilising state of the art machinery and processes backed by decades of expertise.

The following pages detail the standard connections available. Other connection types can be considered. If you can't find the best connection for your application, please contact your local Parker support. Please note – not all connection types and sizes will be universally possible across the entire product range.

Integral tubing connections – A Parker Superior Advantage

For the ultimate in safety, reliability, speed and ease of installation all valves and manifolds can be specified with solutions offering integral tube connection utilising Parker A-LOK® (Two Ferrule) or CPI™ (Single Ferrule) compression fitting technologies.

For full details of the A-LOK® and CPI™ technologies, please see Catalogue ref. 4190-FMTG.

As standard, hand valves and gauge valves are offered with the traditional external thread and nut or inverted (internal thread) design to inlet and outlet connections. Other ports (such as vent) are offered with Parker unique PTFree connect™ solution (see p. 10).



HNV series hand valve with traditional type fully integrated tube fitting connection.

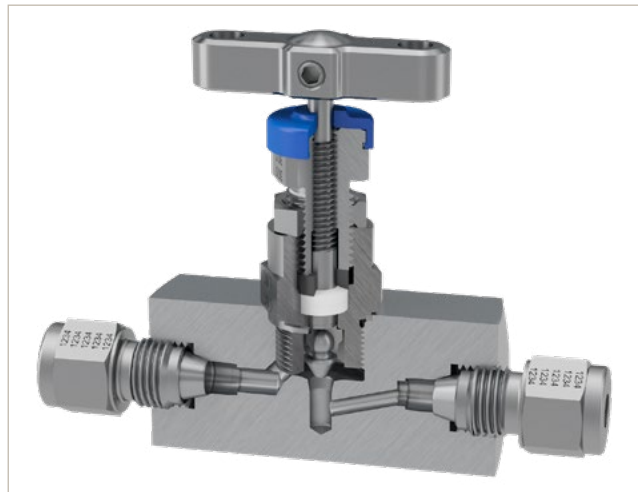

HNV series hand valve with the unique Parker fully integrated inverted tube fitting connection.

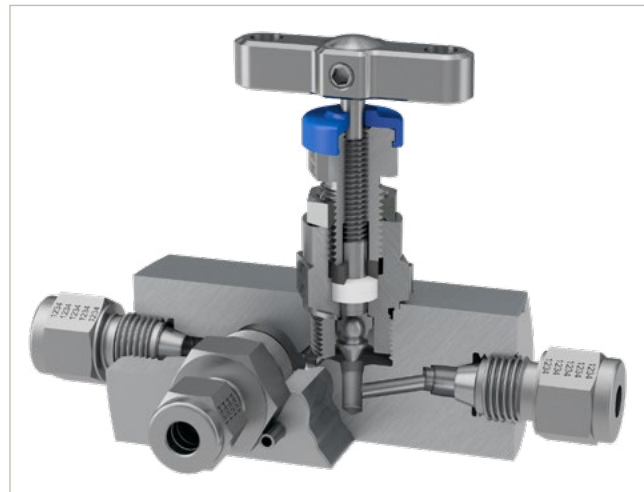

HNV series gauge vent hand valve with inverted tube fitting to inlet and outlet connections with Parker PTFree connect™ tube fitting connection to the vent.

As standard, manifolds are offered with PTFree connect™ style solutions to the inlet connections for direct mount types and also to the outlet connections for remote mount types. Other ports (such as vent) are also offered with Parker Instrumentation's unique PTFree connect™ solution. Some manifold types can be offered with the inverted design to inlet and outlet connections as applicable.



5-valve direct mount manifold for differential pressure applications having inlet and vent connections provided through the use of PTFree connect™ tube fittings.



5-valve direct mount manifold having the Parker superior advantage input connections provided through inverted tube fitting connections. Vent can also be specified as threaded or PTFree connect™.

Why the Superior Advantage of an integrated tube connection?

Consider the following simple example with a typical hand valve.

Example shown is the widely utilised normal specification of a valve and individual tube fittings to achieve the installation.



Component	Cost
Needle valve	1x
Fittings (2)	1.1x
Sealant/Tape	0.01x
Labour	0.15x
TOTAL	2.26x

Example shown is the Parker Superior Advantage fully integrated tube fitting connection.



Component	Cost
Needle valve	1.6x
Fittings (2)	0x
Sealant/Tape	0x
Labour	0.05x
TOTAL	1.65x

Integrated tube connections deliver:

- Average 25% saving on installed cost
- Average 55% saving on installation time
- Zero rework
- Significantly improved safety and system integrity

Connections

Tube end dimensional data

Size No.	Inches					
	Tube O.D.	Straight Thread	†C	H Hex	E Dia.	†D Tube Ins. Depth
1	1/16	10-32	.43	5/16	.052	.34
2	1/8	5/16-20	.60	7/16	.093	.50
3	3/16	3/8-20	.64	1/2	.125	.54
4	1/4	7/16-20	.70	9/16	.187	.60
5	5/16	1/2-20	.73	5/8	.250	.64
6	3/8	9/16-20	.76	11/16	.281	.67
8	1/2	3/4-20	.87	7/8	.406	.90
10	5/8	7/8-20	.87	1	.500	.96
12	3/4	1-20	.87	1-1/8	.625	.96
14	7/8	1-1/8-20	.87	1-1/4	.750	1.03
16	1	1-5/16-20	1.05	1-1/2	.875	1.24
20	1-1/4	1-5/8-20	1.52	1-7/8	1.09	1.61
24	1-1/2	1-15/16-20	1.77	2-1/4	1.34	1.96
32	2	2-5/8-20	2.47	2-3/4	1.81	2.65

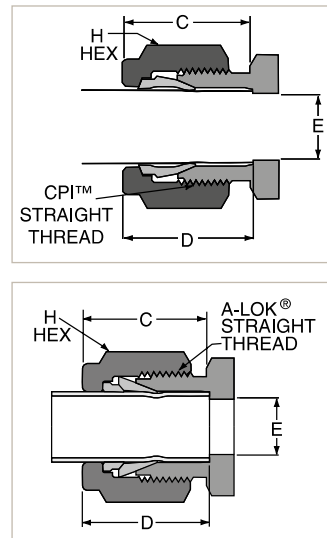

Size No.	Milimeters					
	Tube O.D.	Straight Thread	†C	H Hex	E Dia.	†D Tube Ins. Depth
2	2mm	5/16-20	15,3	12,0	1,7	12,9
3	3mm	5/16-20	15,3	12,0	2,4	12,9
4	4mm	3/8-20	16,1	12,0	2,4	13,7
6	6mm	7/16-20	17,7	14,0	4,8	15,3
8	8mm	1/2-20	18,6	15,0	6,4	16,2
10	10mm	5/8-20	19,5	18,0	7,9	17,2
12	12mm	3/4-20	22,0	22,0	9,5	22,8
14	14mm	7/8-20	22,0	24,0	11,1	24,4
15	15mm	7/8-20	22,0	24,0	11,9	24,4
16	16mm	7/8-20	22,0	24,0	12,7	24,4
18	18mm	1-20	22,0	27,0	15,1	24,4
20	20mm	1-1/8-20	22,0	30,0	15,9	26,0
22	22mm	1-1/8-20	22,0	30,0	18,3	26,0
25	25mm	1-5/16-20	26,5	35,0	21,8	31,3

Notes:

- Dimensions C and D are shown in the finger-tight position.
- † Average value
- Dimensions for reference only, subject to change.

PTFree connect™



Many users desire the elimination of taper threads and their associated sealant.

The PTFree connect™ system enables users to assemble tube lines to any of the manifold ports without the need for PTFE tape or liquid sealant.

The PTFree connect™ connection can be applied to any of the manifolds featured in this catalogue. These will be factory fitted, pin locked and pressure tested.

PTFree connect™ enables angled tube connections to be swivelled to achieve optimum tube alignment. Assembly to the tube connector is achieved by tightening the standpipe nut one-quarter turn from the finger-tight position.

Manifolds can also be supplied with male connectors using the same thread form as the PTFree connect™. They are provided factory fitted, pin locked and tested.

Some size restrictions may be necessary due to the close proximity of some connections and the across flat hexagon dimensions. As a guide, PTFree connect™ for inlet and outlet can be up to 1/2" or 12mm o/d, drain/bleed connections should be restricted to 1/4" or 6mm. For PTFree connect™ male connectors inlet and outlet should be restricted to 3/8" or 10mm and 1/4" or 6mm o/d for drain/bleed.

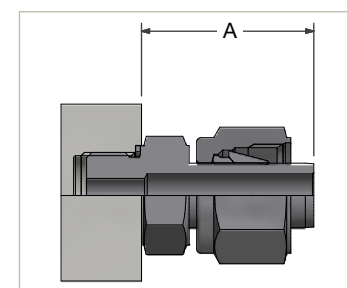

PTFree connect™ tube stub (Code PF)

Tube size	Dimension (A)
6mm	22.26mm 0.88"
1/4"	24.80mm 0.98"
10mm/3/8"	26.40mm 1.04"
12mm/1/2"	32.10mm 1.26"

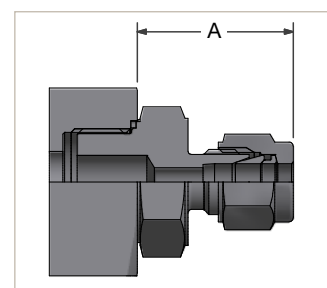

PTFree connect™ male connector (Code PFC)

Tube size	Dimension (A)
6mm	26.90mm 0.95"
1/4"	24.10mm 0.84"
10mm/3/8"	27.70mm 1.09"
12mm/1/2"	30.30mm 1.20"

Other connections

Tapered Pipe Threads - Male and Female



NPT Tapered Thread
NPT Tapered Thread conforming to ASME B1.20.1 with enhanced manufacturing tolerance for optimal assembly and inspected by three step gauging with Parker enhanced tolerancing to ANPT requirement per ASTM SAE AS71051.



BSP Tapered Thread (Code K)
BSP Tapered Thread conforming to BS21, ISO7/1 (R 1/2 - Male, Rc 1/2 Female) with enhanced manufacturing tolerance for best optimal assembly and inspected using gauging system to BS21.

Parallel Pipe Threads - Male and Female



BSP Parallel Thread - Default standard (Code R)
BSP Parallel Thread conforming to BS2779, ISO 228/1+2, DIN 3852. Not available on all product/model types, please consult with your local Parker support.



BSP Parallel Gauge connection type - Optional (Code RD)
According to DIN 16284/16288/ DIN EN 837.
Thread conforming to BS2779, ISO228/1+2, DIN 3852. Not available on all product/model types, please consult with your local Parker support.

Weld Connections



Socket Weld (Code SW/MSW)
Female or male Socket Weld connection suitable for pipe conforming to ASME B16.11, EN12760.

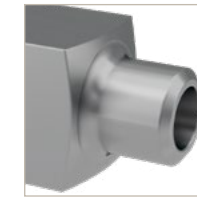

Butt Weld (Code BW)
Butt Weld connection suitable for pipe conforming to ASME B16.25, EN12627.

Notes:

- Valves with female socket weld connections will be of the same length as per the equivalent NPT pipe threaded variants.
- Valves with male socket weld connections will, as standard, have a stub length increase of 1/2" (13mm) when compared to the male pipe threaded equivalent variants.

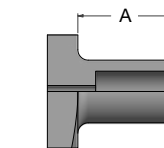

Pipe size	Dimension (A)
4 (1/4" NB)	29
6 (3/8" NB)	29
8 (1/2" NB)	32
12 (3/4" NB)	35

Optional lengths:

If requested, male socket welds or butt welds can be offered with stub length of 75mm or 100mm.

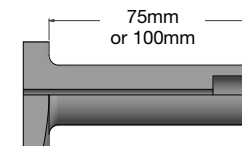

Flange Connections

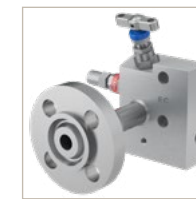

Process Flange
Flange connections can be considered if conforming to ANSI B16.5 and executed in various ways. Please consult your local Parker support.
Not available on all product types.

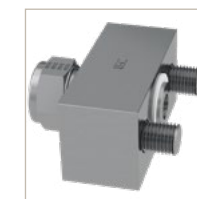

Instrument Flange (Code HK)
DIN/IEC 61518 compliant instrument (kidney/oval) flange connections.

Connections

Transmitter flange connections - DIN/IEC 61518

As standard, Parker manifolds have inlet and outlet interface connections in full accordance with DIN/IEC 61518. For the Manifold to Transmitter interface, the type B connection is standard, type A is optionally available.

Within DIN/EN 61518 the manifold-transmitter interface is rated for maximum allowable working pressure of 413 bar (6,000 psi) and maximum allowable temperature of 120°C (248°F) for liquids,

gas or vapours. The maximum allowable temperature of 120°C (248°F) considers the requirement that manifolds and transmitters need to be protected against undue heating by hot media. This requirement should be achieved by using adequate hook-ups or by instrument impulse lines with sufficient length. However, Parker confirms that H series manifolds can be used for temperatures up to 538°C (1,000°F) with graphite gland packing and up to 260°C (500°F) with PTFE gland packing.

Process inlet to manifold / transmitter interface DIN EN 61518 / IEC 61518

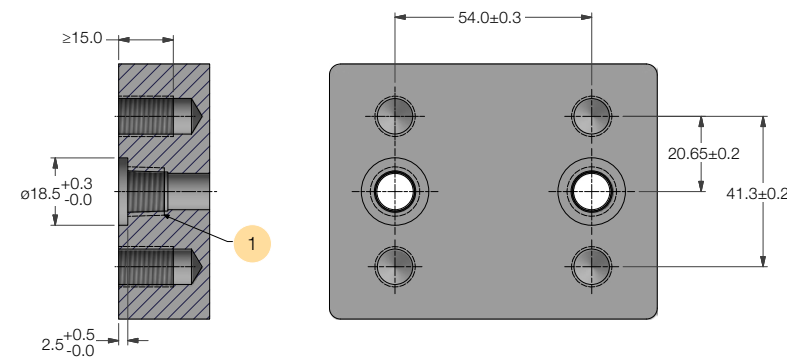

Reference	Description
1	Threaded option for transmitters - plug/vent valve

Parker manifold outlet to transmitter interface DIN EN 61518 / IEC 61518 Type B and Type A

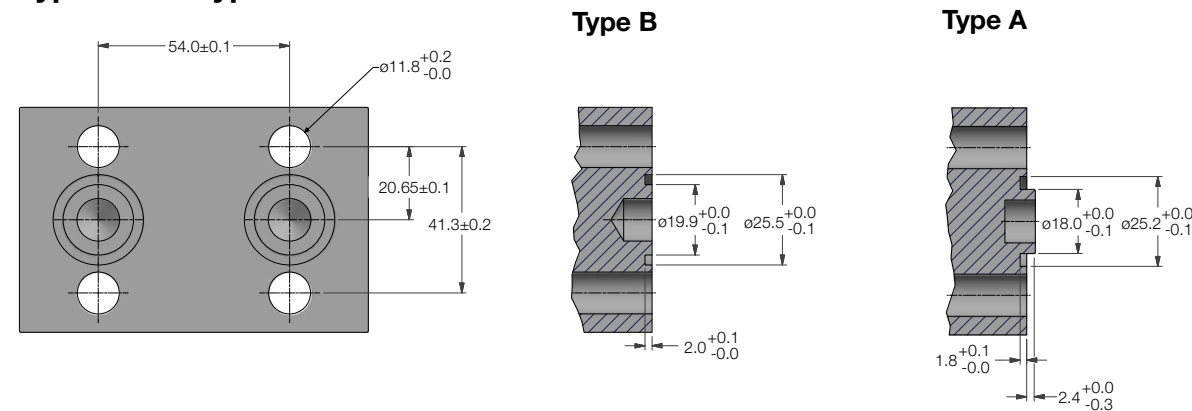

	Type B (Standard)		Type A (Optional)	
Max. Allowable Working Pressure	413 bar (6,000 PSI)		413 bar (6,000 PSI)	
Temperature range	PTFE: -10°C to +80°C (14°F to 176°F)	Graphite: -40°C to +120°C (-40°F to 248°F)	PTFE: -10°C to +80°C (14°F to 176°F)	Graphite: -15°C to +120°C (5°F to 248°F)
Seal ring	Flat Ring 25.4 x 20 x 2.7 Material: PTFE	Flat Ring 25.4 x 19.9 x 2.9 Material: Graphite	Flat Ring 24 x 17.7 x 2.7 Material: PTFE	Flat Ring 25.1 x 18.0 x 2.9 Material: Graphite
Min. Thread Engagement	9mm		9mm	
Spare/Replacement Seal part No.	HIEC001-PTFE/1	HIEC001-GRAPHITE/1	HIEC002-PTFE/1	HIEC002-GRAPHITE/1

Connection at the manifold acc. to DIN/IEC 61518.

Important Note - there are some exceptions to the IEC 61518 standard:

- Emerson Coplanar™ transmitter design. Parker offers a full range of specifically suitable manifolds for this type. See pages 55-60.
- There is a limited range of other higher working pressure transmitters by some manufacturers, where the interface is proprietary by design (Example: Yokogawa EJX 440A/EJA 440E). Parker is able to provide manifold designs that are complementary to those products. Please consult your local Parker support.

Bonnet Assemblies

Standard bonnet design

Class 2500 (6,000 PSI) and Class 4500 (10,000 PSI)

For safe, reliable and repeatable performance

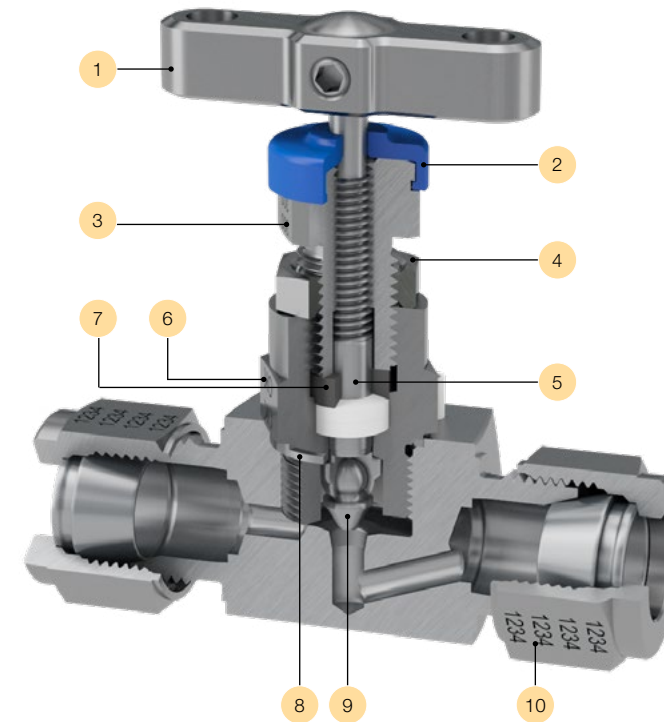

Reference	Description
1	Ergonomic 'T' bar style handle with positive retention
2	Dual purpose dust cap provides functional identification
3	Compensatory adjustable gland
4	Secure anti-vibration gland lock nut
5	Anti-blowout low torque back seating stem
6	All metal body bonnet seal
7	Gland thrust bush ensures uniform packing compression and tight sealing
8	Annealed sealing washer guarantees 100% sealing assurance
9	Self-centering, non-rotating stem tip guarantees bubble tight shut off
10	Material traceability for major pressure containing components

Notes:

- As standard, all metallic parts are 316 Stainless Steel. Optional materials are available, please see page 6.
- For products specified in optional materials, non-wetted parts will be 316 Stainless Steel as standard.
- 6,000 PSI bonnet thread is M16; 10,000 PSI bonnet thread is M18.

Pressure vs temperature

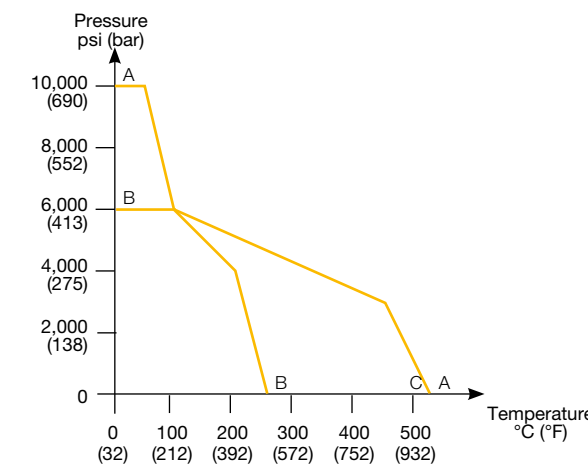

Reference	Description
A - A	Graphite packing
A - B	PTFE packing
B - B	6,000 PSI (414 bar) standard PTFE packing
B - C	6,000 PSI (414 bar) standard Graphite packing

Notes:

- Pressure and temperature ratings shown are maximum possible values. Continuous operation at the maximum ratings will reduce life expectancy.
- Pressure and temperature ratings can be derated by certain connection types or materials of construction.

Bonnet Assemblies

Larger bore bonnet design
Class 2500 (6,000 PSI) and Class 4500 (10,000 PSI)



Features

- 6mm seat orifice size, allowing the provision of larger 5mm or 6mm flow passages
- Ideal for applications with dirtier/denser service media and/or those prone to blocking in small bore installations
- Can enhance other aspects of performance and measurement accuracy
- Will result in the use of larger body material sizes
- Not possible for all styles and types of product
- All other technical information remains unchanged from standard

Soft seat tip bonnet design



Features

- Available in the 4mm orifice size only, this PEEK seat tip option is available for all product styles and types
- Ideal for clean gaseous or other services where bubble-tight shut-off with minimum effort is required
- Suitable for temperatures up to 204°C and pressures up to 10,000 psi at reduced temperature, as per graph
- For larger bore requirements Parker recommends Rising Plug valve

Pressure vs temperature

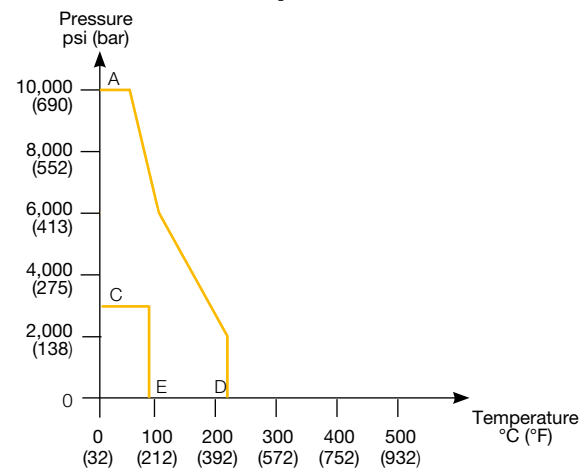

Reference	Description
A - D	PEEK tip
C - E	PCTFE tip - Temperature limit 150°C (302°F) at 3,000 psi (207 bar)

Fire safe bonnet design - Class 2500 (6,000 PSI)

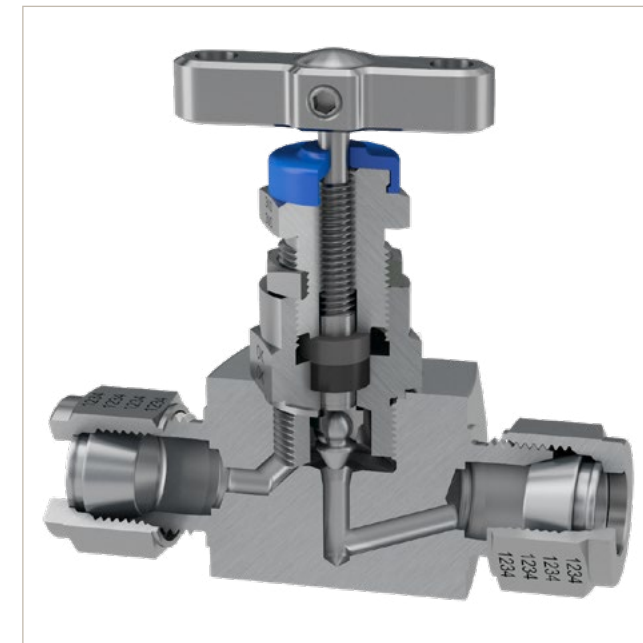

Features

- Specifically designed and developed to meet exacting industry requirements, products incorporating this Bonnet Design conform to BS 6755 Part 2, API 6FA / API607. For further details contact your local Parker support.
- 100% fire safe design certified, many typical actual third party test certificates are available for review
- Available for most product styles and types
- Some material selections are restricted

Power plant bonnet design

Compliant to ANSI B31.1 – Class 2500 (6,000 PSI)



Features

- Available in a select range of body styles and types. Please consult your local Parker support
- Designed specifically to meet the requirements of ANSI B31.1 (Power Plants) and B31.3 (Petrochemical Plants) including materials of construction, these bonnet assemblies are Graphite packed for higher temperature service
- Suitable for temperatures up to 538°C and pressures up to 6,000 psi at reduced temperature, as per graph
- Unique patented Tru-Loc® safety bonnet lock further enhances security in application

Pressure vs temperature

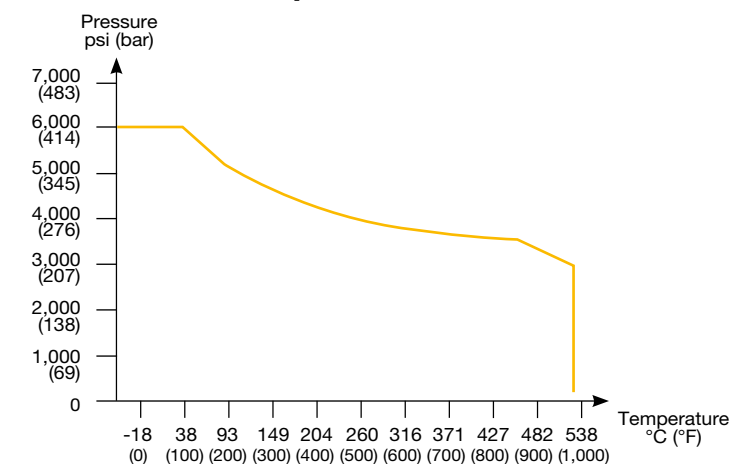

To order valves and manifolds with power plant bonnet design, follow the part builder structures as on pages 26-27, 32-33, 46-47 and replace **H** in the series names with **HPP**. Consult your local Parker support for available options.

Examples:

- HPPNVS8FF3** - Hand valve
- HPPLS2V3** - 2-valve remote mount flat barstock manifold
- HPPLS5M3** - 5-valve remote mount flat barstock manifold
- HPPDS5M3** - 5-valve direct mount flat barstock manifold

Bonnet Assemblies

Rising plug bonnet design



Features

- HRPV valve is unique to Parker and is patent-protected
- Non-rotating plug/tip
- Dynamic response moulded seat insert with guaranteed alignment
- Standard straight through orifice size: 1/4" (6.4mm)
- Cv: 1.8
- Rolled spindle operating threads
- Straight through flow path
- Multi-port gauge style available as standard. Other styles can be considered - please consult the factory
- Bi-directional flow
- Backstop spindle for blowout prevention and minimal atmospheric leakage
- Low torque operating T bar handle
- Externally adjustable gland
- Full range of head options available
- Dust cap to prevent ingress of contamination to operating thread
- Bonnet locking pin fitted as standard
- Suitable for temperatures up to 204°C and pressures up to 10,000 psi at reduced temperature, as per graph

Pressure vs temperature

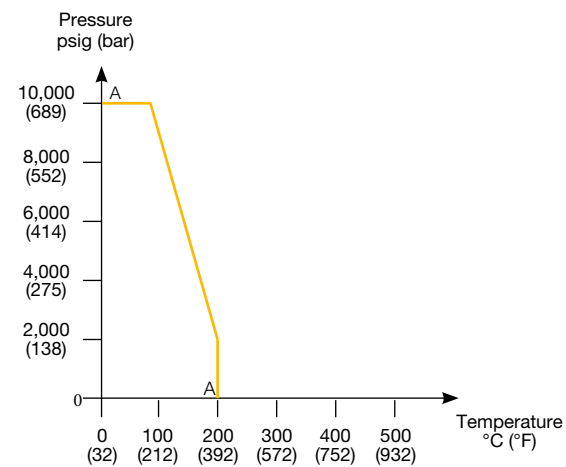

Reference	Description
A - A	PEEK Seat

Tru-Loc® safety bonnet lock

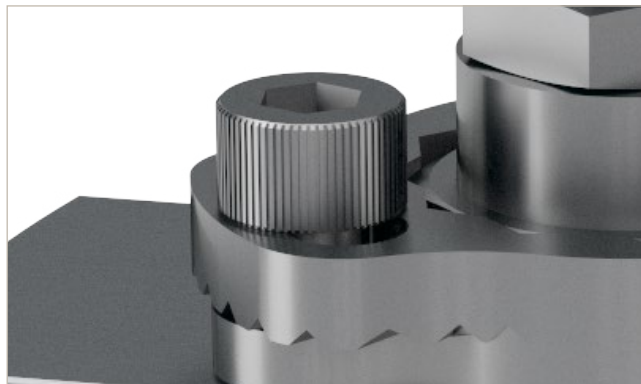

Available as standard on ANSI/ASME B31.1 manifold versions, the unique Parker Tru-Loc® security locking system is applied to the body to bonnet interface but can also be applied to many other screwed component interfaces. Extensive tests have proven that threaded connection interfaces secured with Tru-Loc® guarantee 100% security in preventing movement between connected components. In the H series manifolds it prevents loosening or removal of the bonnet assembly by any means.

Low emission bonnet design

TA-Luft compliant

As standard, products fitted with the Parker Instrumentation standard bonnet assembly are bubble tight in service and have been proven to meet the requirements of **TA-Luft 2002, Absatz 5.2.6.4 und VDI 2440 (Ausgabe Nov. 2000), Absatz 3.3.1.3.**

ISO 15848 compliant

From 2007 EU's IPPC directive 96/61/EC legislates for the minimisation of pollution from industrial sources (Many other regions and countries have similar legislation). An important part of this legislation is reducing Ultra-Low emissions. According to the IPPS, all plants and factories which fail to comply with the standards set by the directive, may face closure.

The legislation introduced a concept of Best Available Technique (BAT), urging plants to find the best available solution for reducing Ultra-Low emissions throughout all processes. With respect to valves, ISO 15848 parts 1 and 2 were developed to aid companies to meet the legislation.

Part 1 covers the classification system and qualification procedure for type testing of valves. The standard specifies three tightness classes of leakage with respect to stem sealing diameter. These classes are class A, B and C; class A having the smallest environmental leakage. Each class level is one hundred fold lower than the class above i.e. a class B product may have a leakage of 100 times that of a class A product. The standard also specifies the duty that the valve has been tested to.

Parker Instrumentation specifically developed an H series Bonnet Assembly design with class A approval to ISO 15848-1. Classed 'FE', products specified with these bonnet assemblies are certified as **ISO FE AH-C01-SSA1-t(RT,180°C)-ANSI2500-ISO 15848-1.** These products are further classified as meeting the ISO 15848-1 standard with the following criteria;

- Class A tested with Helium
- Endurance class C01 – a mechanical valve which has been tested throughout 500 mechanical actuations with two thermal cycles
- Temperature class RT-180°C – fully thermal cycled and tested from -29°C to +180°C pressure class ANSI 2500 – 6000 psi in 316 Stainless Steel.

Part 2 of the standard covers production acceptance testing of valves. This production testing can only be carried out to product which has already been approved to part 1 of the standard. Parker can offer production testing and certification to a sampling percentage specified by the purchaser. A third party witnesses can also be considered.



Bonnet Assemblies

Low emission bonnet design

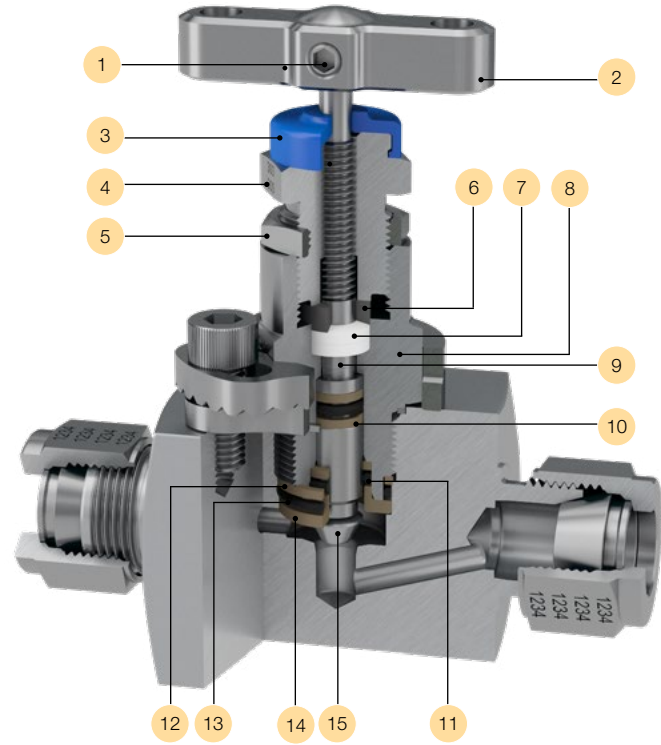

Reference	Description
1	Positive handle retention
2	"T" bar
3	Dust cap
4	Gland packing adjuster
5	Gland adjuster lock nut
6	Thrust bush
7	Gland packing (adjustable)
8	Valve bonnet
9	Anti blow-out spindle
10	Anti extrusion ring
11	Elastomeric o-ring (stem seal)
12	Anti-extrusion ring
13	Elastomeric o-ring (body seal)
14	Bonnet end cap
15	Spindle tip

Pressure vs temperature

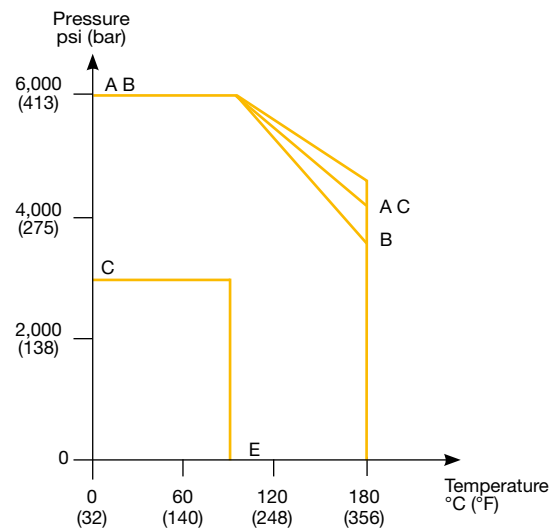

Reference	Description
A - A	Graphite packing
A - B	PTFE packing
B - B	6,000 PSI (414 bar) standard PTFE packing
B - C	6,000 PSI (414 bar) standard Graphite packing
A - D	PEEK tip
C - E	PCTFE tip

Features

- Tightness class $A \geq 1 \times 10^{-6} \text{ mg.s}^{-1}.\text{m}^{-1}$
- Maximum cold working pressure rating 6,000 psig (414 barg)
- Temperature rating -29°C to 180°C (-20°F to 356°F)
- ISO15848-1 prototype tested using global helium vacuum method
- Performance class – ISO FE AH-C01-SSA1-t(RT,180°C)-ANSI2500-ISO 15848-1
- Production testing and certification available on request)
- O-ring material grade is Fluoroelastomer FKM Tetrapolymer, specially formulated for explosive decompression (ED) resistance. These seals are qualified to the stringent NORSOK M-170 standard covering both ED resistance and sour gas (H2S) ageing tests
- Available for most product styles and types
- Also meets the requirements per; TA-Luft according to VDI 2440 as tested by TUV SUD Industrie Service GMBH performing better than a leakage rate of VDI 2440 = 10 -4 mbar .l /s . m

Bonnet assembly options

Available as a factory fit or as retrofit, these useful bonnet assembly options are provided in all 316 Stainless Steel material. For locking options padlocks are not provided but the hole size in all cases is 6mm (0.24"). To obtain factory fit options, your specified product part number must be suffixed with the additional option part numbers as below. Some options can be combined.



T bar handle locking

Retrofit Kit Part Number	Factory Fitted Suffix
KITTHL	HL



Handwheel

Retrofit Kit Part Number	Factory Fitted Suffix
KITTHW	HW



Anti-tamper spindle

	Retrofit Kit Part Number	Factory Fitted Suffix
With Key	KITAK	ATK
Without Key	KITAT	AT



Lockable handwheel

Retrofit Kit Part Number	Factory Fitted Suffix
KITLHW	LHW



Key

Key only Part Number
ATHKEY



Anti-tamper handwheel

Key only Part Number
ATHWKEY



Panel mounting

Retrofit Kit Part Number	Factory Fitted Suffix
KITPM	PM
Hole Diameter	26mm (1.02")
Panel Thickness	Max. 5mm (0.20") Min. 2.3mm (0.09")
Min. distance for panel mount spacing	51mm (2.00")



Hand Valves & Gauge Valves

Introduction

Following years of valve design and development, the Parker needle pattern hand and gauge valves range is one of the most comprehensive to be found. The valves are available to users from a wide market spectrum and are suitable for all industries and applications.

In combination with Parker A-LOK® or CPI™ compression tube fitting technologies, a superior advantage is gained allowing users to eliminate threaded connections and reduce leak paths whilst offering superior installation and operational performance.

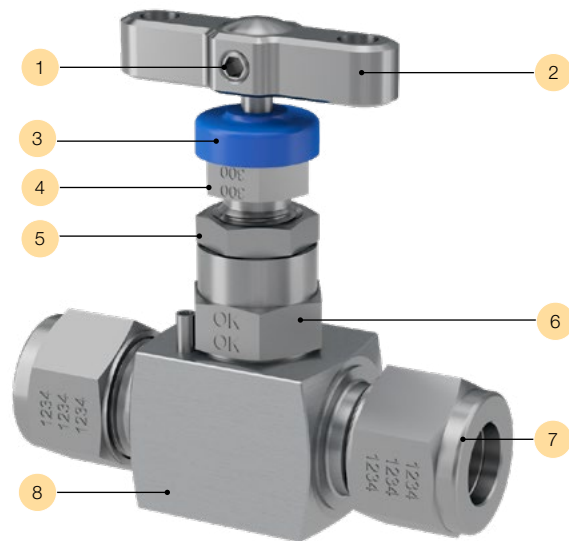

Reference	Description
1	Locked grub screw
2	"T" bar handle
3	Dust cap
4	Gland packing adjuster
5	Gland adjuster lock nut
6	Valve bonnet
7	Integral A-LOK® connection
8	Body



Example shown: Multi-port gauge valve with Parker Superior Advantage integral A-LOK® tube fitting connections.

They are used in every industry in a wide range of applications - anywhere where accurate and secure control or metering of steam, air, gas, oil, water or other non-viscous liquids is required.

Utilising these same attributes, the Parker needle pattern gauge valves will be found controlling flow into a vast array of measurement and analysis instrumentation such as pressure gauges, transmitters, switches and more. With additional functionality these gauge valves also allow users to provide vent, drain or blowdown routes to their process and/or the ability to attach additional instruments and accessories.

We are confident you will find a valve style, type and connection option to suit your applications, but should you require something different please contact your local Parker support.

Example shown: Hand valve with Parker Superior Advantage integral CPI™ tube fitting connections.

Hand Valves - HNV Series

Straight pattern

HNV* - Integral A-LOK® connections - up to 6,000 PSI

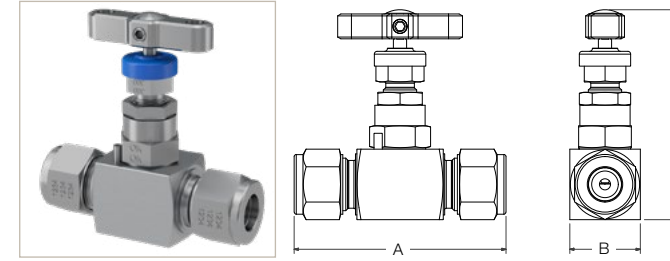

Inlet	Outlet	Dimension		
A-LOK®	A-LOK®	A mm (inch)	B mm (inch)	C mm (inch)
1/4"	1/4"	67.5 (2.66")	25.4 (1.00")	76.2 (3.00")
1/2"	1/2"	76.2 (3.00")	25.4 (1.00")	76.2 (3.00")
6mm	6mm	67.5 (2.66")	25.4 (1.00")	76.2 (3.00")
12mm	12mm	76.2 (3.00")	25.4 (1.00")	76.2 (3.00")

HNV* - Integral CPI™ connections - up to 6,000 PSI

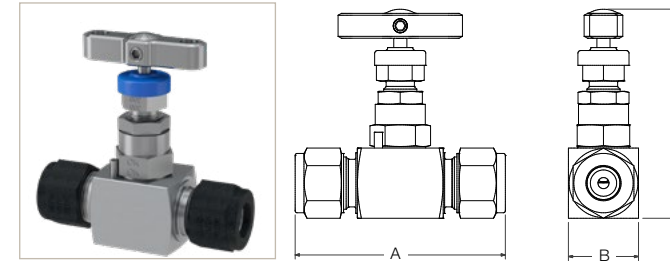

Inlet	Outlet	Dimension		
CPI™	CPI™	A mm (inch)	B mm (inch)	C mm (inch)
1/4"	1/4"	67.5 (2.66")	25.4 (1.00")	76.2 (3.00")
1/2"	1/2"	76.2 (3.00")	25.4 (1.00")	76.2 (3.00")
6mm	6mm	67.5 (2.66")	25.4 (1.00")	76.2 (3.00")
12mm	12mm	76.2 (3.00")	25.4 (1.00")	76.2 (3.00")

Integral connections - up to 10,000 PSI

A limited range of integral connections for 10,000 PSI is available as tube selection can adversely affect overall product ratings. Please consult your local Parker support.

HNV* - Female threaded - NPT

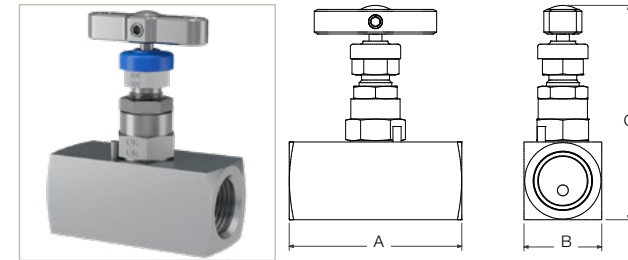

Pressure (PSI)	Inlet	Outlet	Dimension		
	Female	Female	A mm (inch)	B mm (inch)	C mm (inch)
6,000	1/4" NPT	1/4" NPT	54.0 (2.13")	28.6 (1.13")	79.4 (3.13")
	3/8" NPT	3/8" NPT	54.0 (2.13")	28.6 (1.13")	79.4 (3.13")
	1/2" NPT	1/2" NPT	63.5 (2.50")	28.6 (1.13")	79.4 (3.13")
10,000	1/4" NPT	1/4" NPT	60.5 (2.38")	31.8 (1.25")	82.6 (3.25")
	1/2" NPT	1/2" NPT	69.9 (2.75")	31.8 (1.25")	82.6 (3.25")

HNV* - Male x Female threaded - NPT

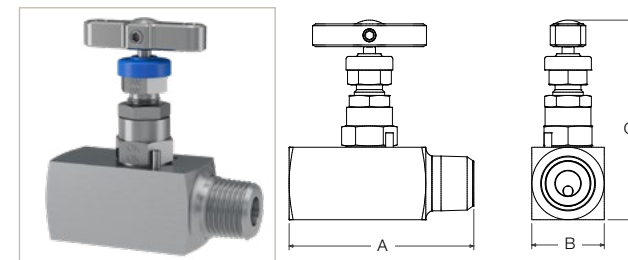

Pressure (PSI)	Inlet	Outlet	Dimension		
	Male	Female	A mm (inch)	B mm (inch)	C mm (inch)
6,000	1/4" NPT	1/4" NPT	57.8 (2.27")	28.6 (1.13")	79.4 (3.13")
	1/2" NPT	1/2" NPT	73.0 (2.87")	28.6 (1.13")	79.4 (3.13")
10,000	1/4" NPT	1/4" NPT	62.8 (2.47")	31.8 (1.25")	82.6 (3.25")
	1/2" NPT	1/2" NPT	76.2 (3.00")	31.8 (1.25")	82.6 (3.25")

Notes:

- Dimension "A" given for finger-tight nuts and ferrules.
- Dimension "C" in open position.

Hand Valves - HNAV Series

Angle pattern

HNAV* - Integral A-LOK® connections - up to 6,000 PSI

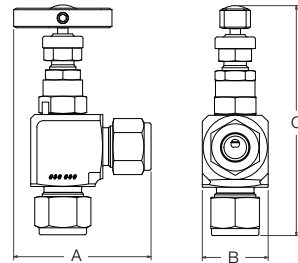

Inlet	Outlet	Dimension		
		A mm (inch)	B mm (inch)	C mm (inch)
A-LOK® 1/4"	A-LOK® 1/4"	58.4 (2.30)	30.1 (1.19)	100.8 (3.97)
1/2"	1/2"	62.9 (2.48)	30.1 (1.19)	105.3 (4.15)
6mm	6mm	58.4 (2.30)	30.1 (1.19)	100.8 (3.97)
12mm	12mm	62.9 (2.48)	30.1 (1.19)	105.3 (4.15)

HNAV* - Integral CPI™ connections - up to 6,000 PSI

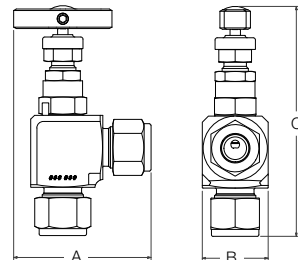

Inlet	Outlet	Dimension		
		A mm (inch)	B mm (inch)	C mm (inch)
CPI™ 1/4"	CPI™ 1/4"	58.4 (2.30)	30.1 (1.19)	100.8 (3.97)
1/2"	1/2"	62.9 (2.48)	30.1 (1.19)	105.3 (4.15)
6mm	6mm	58.4 (2.30)	30.1 (1.19)	100.8 (3.97)
12mm	12mm	62.9 (2.48)	30.1 (1.19)	105.3 (4.15)

Integral connections - up to 10,000 PSI

A limited range of integral connections for 10,000 PSI is available as tube selection can adversely affect overall product ratings. Please consult your local Parker support.

HNAV* - Female threaded - NPT

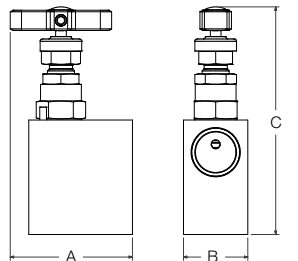

Inlet	Outlet	Dimension		
		A mm (inch)	B mm (inch)	C mm (inch)
Female 1/4" NPT	Female 1/4" NPT	49.5 (1.95)	25.4 (1.00)	88.3 (3.47)
1/2" NPT	1/2" NPT	54.3 (2.14)	28.6 (1.13)	101.0 (3.98)

HNAV* - Male x Female threaded - NPT

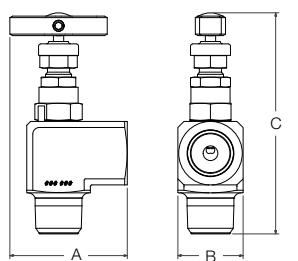

Inlet	Outlet	Dimension		
		A mm (inch)	B mm (inch)	C mm (inch)
Male 1/4" NPT	Female 1/4" NPT	49.5 (1.95)	30.1 (1.19)	98.7 (3.89)
1/2" NPT	1/2" NPT	54.3 (2.14)	30.1 (1.19)	102.2 (4.02)

Notes:

- Dimension "A" given for finger-tight nuts and ferrules.
- Dimension "C" in open position.

Gauge Valves - HNVV Series

Single block gauge vent valves

Generally used in conjunction with the measuring instrument, these valves allow for the function of venting/draining any process media that may be trapped, following isolation of the instrument for maintenance and/or removal purposes.



Example shown: HNVV single block gauge vent valve with Parker Superior Advantage integral inverted A-LOK® tube connections to inlet and outlet and with Parker PTFree connect™ to the vent.

HNVV* - Male x Female threaded - NPT

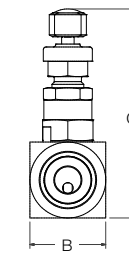
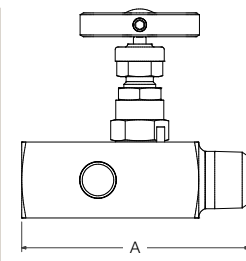

Pressure (PSI)	Inlet Male	Outlet Female	Vent Female	Dimension		
				A mm (inch)	B mm (inch)	C mm (inch)
6,000	1/4" NPT	1/4" NPT	1/4" NPT	72.5 (2.85)	28.6 (1.13)	79.4 (3.13)
	1/2" NPT	1/2" NPT	1/4" NPT	85.8 (3.38)	28.6 (1.13)	79.4 (3.13)
10,000	1/4" NPT	1/4" NPT	1/4" NPT	71.2 (2.80)	31.8 (1.25)	82.6 (3.25)
	1/2" NPT	1/2" NPT	1/4" NPT	85.6 (3.37)	31.8 (1.25)	82.6 (3.25)

HNVV* - Female x Female threaded - NPT

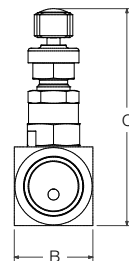
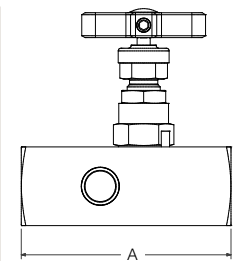

Pressure (PSI)	Inlet Female	Outlet Female	Vent Female	Dimension		
				A mm (inch)	B mm (inch)	C mm (inch)
6,000	1/4" NPT	1/4" NPT	1/4" NPT	63.5 (2.50)	28.6 (1.13)	79.4 (3.13)
	1/2" NPT	1/2" NPT	1/4" NPT	76.3 (3.00)	28.6 (1.13)	79.4 (3.13)
10,000	1/4" NPT	1/4" NPT	1/4" NPT	69.0 (2.71)	31.8 (1.25)	82.6 (3.25)
	1/2" NPT	1/2" NPT	1/4" NPT	79.5 (3.13)	31.8 (1.25)	82.6 (3.25)

HNVV* - Male x Male threaded - NPT

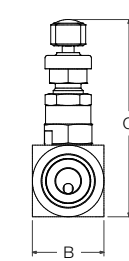
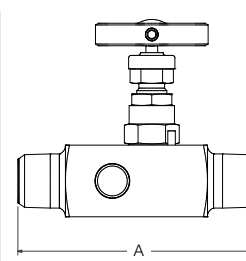

Pressure (PSI)	Inlet Male	Outlet Male	Vent Female	Dimension		
				A mm (inch)	B mm (inch)	C mm (inch)
6,000	1/4" NPT	1/4" NPT	1/4" NPT	76.2 (3.00)	28.6 (1.13)	79.4 (3.13)
	1/2" NPT	1/2" NPT	1/4" NPT	94.8 (3.73)	28.6 (1.13)	79.4 (3.13)
10,000	1/4" NPT	1/4" NPT	1/4" NPT	76.2 (3.00)	31.8 (1.25)	82.6 (3.25)
	1/2" NPT	1/2" NPT	1/4" NPT	94.8 (3.73)	31.8 (1.25)	82.6 (3.25)

Notes:

- Dimension "A" given for finger-tight nuts and ferrules.
- Dimension "C" in open position.
- For bleed/vent valves and plugs see page 61.

Products shown here can be supplied with integral swivel gauge adaptor as shown on page 24.

Gauge Valves - HGV Series

Multi-port gauge valves

Parker's multi-port gauge valves are purpose designed valves for operation up to 6,000 psig (414 barg) and 10,000 psig (689 barg). Featuring as standard PTFE gland packing and self-centering non-rotational tip for bubble-tight seat shut-off, these valves give the user the assurance of safety and performance.



Example shown: Multi-port gauge valve with integral A-LOK® connections.

HGV* - Male x Female (3 outlets) threaded - NPT

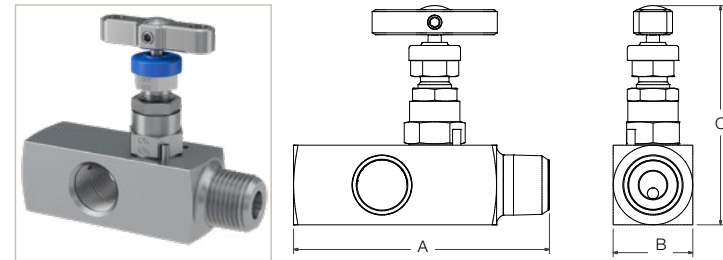

Inlet	Outlet	Dimension		
		A mm (inch)	B mm (inch)	C mm (inch)
Male	Female			
1/4" NPT	1/4" NPT	72.5 (2.85)	28.6 (1.13)	79.4 (3.13)
1/2" NPT	1/2" NPT	92.0 (3.62)	28.6 (1.13)	79.4 (3.13)
Male	Male*			
1/2" NPT	1/2" NPT	97.2 (3.82)	28.6 (1.13)	79.4 (3.13)

*Optional outlet

HGVX* - Male Extended x Female (3 outlets) threaded - NPT

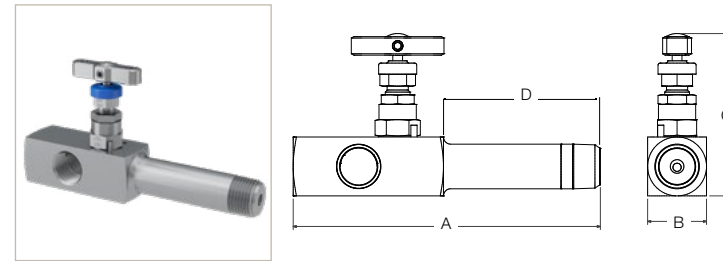

Inlet	Outlet	Dimension			
		A mm (inch)	B mm (inch)	C mm (inch)	D mm (inch)
Male	Female				
1/2" NPT	1/2" NPT	148.0 (5.83)	28.6 (1.13)	79.4 (3.13)	75.0 (2.95)*

- * Example part numbers:
 • 1/2" NPT Male inlet - default extension: 75mm (2.95"), 1/2" NPT Fem. outlet = **HGVXS8M8F**
 • 1/2" NPT Male inlet - optional extension: 100mm (3.94"), 1/2" NPT Fem. outlet = **HGVXS12MD8F** (add **D** for 100mm extension)

HGVWG* - Male x Female (2 outlets) threaded - NPT with integral swivel gauge adaptor

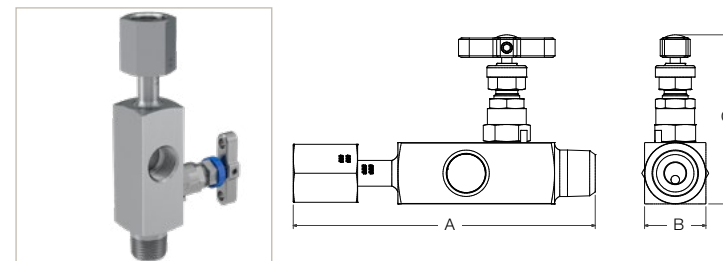

Inlet	Outlet	Dimension		
		A mm (inch)	B mm (inch)	C mm (inch)
Male	Female			
1/2" NPT	1/2" BSPP	140.8 (5.54)	28.6 (1.13)	79.4 (3.13)

- Swivel adaptor to the outlet is provided through a socket weld, generally conforming to ANSI B16.11.
- Weld connection is a "commercial weld", completed by a qualified welder. Any specific qualification, certification, documentation or additional NDT, will require to be engineered and quoted extra - please consult your local Parker support.
- Union nut dimensions generally conform to DIN 16284 as it applies to the union of nipple & nut themselves.
- Union nut also conforms generally to DIN EN 837 for the gauge connection itself, as it applies to the union of nipple and nut themselves.

HGV* - Female x Female (3 outlets) threaded - NPT

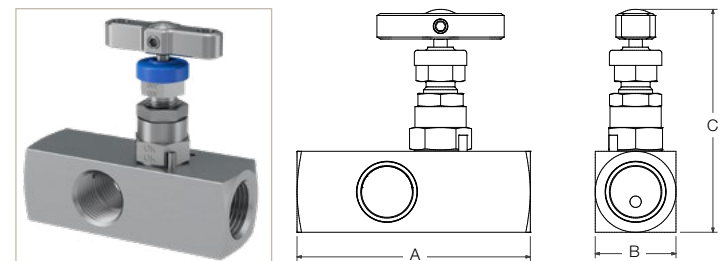

Inlet	Outlet	Dimension		
		A mm (inch)	B mm (inch)	C mm (inch)
Female	Female			
1/2" NPT	1/2" NPT	82.5 (3.25)	28.6 (1.13)	79.4 (3.13)

Notes:

- Dimension "A" given for finger-tight nuts and ferrules.
- Dimension "C" in open position.

Rising Plug Valves - HRPV Series

These unique, high quality, high performance, low-torque rising plug soft-seated valves have been specifically designed to perform with fluids containing high levels of contamination, such as those frequently found in oil and gas processing facilities. With a straight through flow pattern and 100% repeatable bubble-tight shut-off, the valves as standard with PEEK seat will perform up to 10,000 psig (689 barg) with low spindle operating torques.



Example shown: Hand valve with integral A-LOK® connections.

HRPV4* - Male x Female threaded - NPT

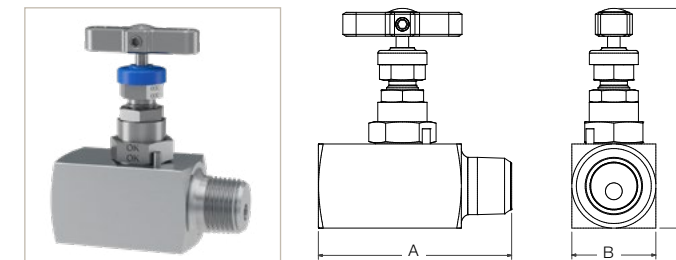

Inlet	Outlet	Dimension		
		A mm (inch)	B mm (inch)	C mm (inch)
Male	Female			
1/2" NPT	1/2" NPT	72.9 (2.87)	31.8 (1.25)	88.0 (3.46)
3/4" NPT	1/2" NPT	72.9 (2.87)	31.8 (1.25)	88.0 (3.46)

HRPV4* - Female x Female threaded - NPT

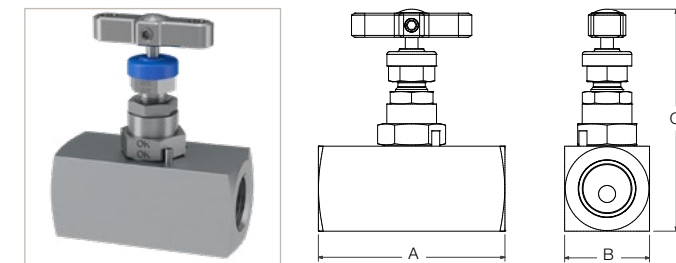

Inlet	Outlet	Dimension		
		A mm (inch)	B mm (inch)	C mm (inch)
Female	Female			
1/4" NPT	1/4" NPT	60.5 (2.38)	31.8 (1.25)	88.0 (3.46)
1/2" NPT	1/2" NPT	69.8 (2.75)	31.8 (1.25)	88.0 (3.46)

HRPV4G* - Male x Female (3 outlets) threaded - NPT

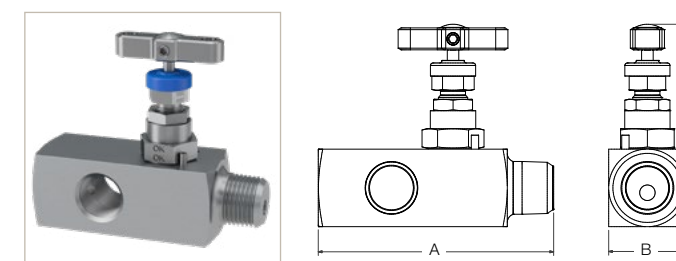

Inlet	Outlet	Dimension		
		A mm (inch)	B mm (inch)	C mm (inch)
Male	Female			
1/2" NPT	1/2" NPT	96.5 (3.80)	31.8 (1.25)	88.0 (3.46)

HRPV4* - Integral A-LOK® connections

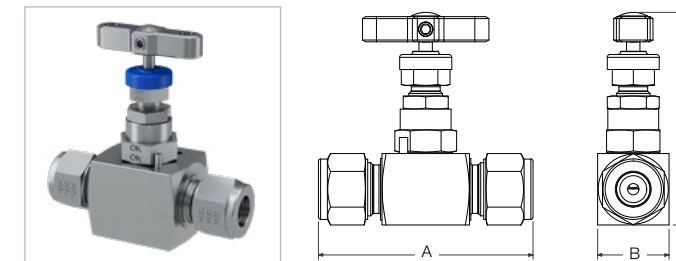

Inlet	Outlet	Dimension		
		A mm (inch)	B mm (inch)	C mm (inch)
A-LOK	A-LOK			
1/2"	1/2"	63.5 (2.50)	31.8 (1.25)	88.0 (3.46)
12mm	12mm	63.5 (2.50)	31.8 (1.25)	88.0 (3.46)

Notes:

- Dimension "A" given for finger-tight nuts and ferrules.
- Dimension "C" in open position.

Products shown here can be supplied with integral swivel gauge adaptor as shown on page 24.

Hand Valves and Gauge Valves

Ordering information

Example 1: **HNVS8M8FHPLHW**

Example 2: **HGV6MO12M8F3PBVBMNC**

Example 3: **HNVVWGS8A8RPBMNC**

Example 4: **HGV6MOIVAM12PFCAM6RTATK**

HNVS	S	8M8F	HPLHW
HGV6MO	6MO	12M8F	3PBVBMNC
HNVVWG	S	8A8R	PBMNC
HGV6MO	6MO	IVAM12PFCAM6	RTATK

- Straight pattern needle valve, 316 Stainless Steel, PTFE packing, 10,000 PSI, 1/2" NPT Male inlet, 1/2" NPT Female outlet with locking handwheel operation.
- Multi-ported Gauge valve, 6MO Super Austenitic Stainless Steel, conforming to NACE MR-01-75 latest revision, Graphite packing, 3/4" NPT Male inlet, 3 x 1/2" NPT Female outlets, with blank plug, bleed valve and base mounting holes.
- Single ported Gauge valve with integral swivel gauge outlet connection, inlet ports are 1/2" A-LOK tube, whilst outlet swivel connection is 1/2" BSPP. The side port in 1/4" NPT fitted with blank plug and the valve has base mounting holes. Material of construction is 316 stainless steel conforming to NACE and gland packing is PTFE.
- Multi-ported Gauge valve, 6MO Super Austenitic Stainless Steel with 12mm Inverted A-LOK tube connections to inlet and outlet, having 6mm A-LOK PTFree connect male connectors to the side ports. Other options are regulating tip with Anti-Tamper operation and one key.

Series	
HNVS	Hand valve straight pattern
HNAV	Hand valve angle pattern
HNVS	Gauge valve single ported ¹
HNVVWG	Gauge valve single ported with Integral Swivel Gauge connection ²
HGV	Gauge valve multi-ported ³
HGVX	Gauge valve multi-ported extended
HGVWG	Gauge valve multi-ported with Integral Swivel Gauge connection ²
HRPV4	Rising plug valve

¹ For single ported gauge valves, port is standard as 1/4" NPT Fem. For other options, see tables.
² Integral welded swivel gauge adaptor for HNVV & HGV model types only as standard as 1/2" BSPP (**8R**), 1/4" BSPP (**4R**) by special request. Available in 316SS as standard. Consult your local Parker representation for other material options.
³ For multi-ported gauge valves, ports (2x) are standard as 1/2" NPT Fem. For other options, see tables.

Materials			
S	316/316L Stainless Steel	HC	Alloy C276
6MO	6MO Sup. Aust. St. Steel	T	Titanium Gr. 2
M	Alloy M400	825	Alloy 825
D1	Duplex 22 Cr. Steel	625	Alloy 625
D2	Super Duplex 25 Cr. Steel	C	Carbon Steel ⁴

⁴ For Carbon Steel consult your local Parker representation.

Connections - Standard					
	Inlet	Outlet		Inlet	Outlet
4FF	1/4" NPT Fem.	1/4" NPT Fem.	4A	1/4" A-LOK ⁵	1/4" A-LOK ⁵
6FF	3/8" NPT Fem.	3/8" NPT Fem.	6A	3/8" A-LOK ⁵	3/8" A-LOK ⁵
8FF	1/2" NPT Fem.	1/2" NPT Fem.	8A	1/2" A-LOK ⁵	1/2" A-LOK ⁵
12FF	3/4" NPT Fem.	3/4" NPT Fem.	M6A	6mm A-LOK ⁵	6mm A-LOK ⁵
16FF	1" NPT Fem.	1" NPT Fem.	M10A	10mm A-LOK ⁵	10mm A-LOK ⁵
4M4F	1/4" NPT Male	1/4" NPT Fem.	M12A	12mm A-LOK ⁵	12mm A-LOK ⁵
6M6F	3/8" NPT Male	3/8" NPT Fem.			
8M8F	1/2" NPT Male	1/2" NPT Fem.			
12M8F	3/4" NPT Male	1/2" NPT Fem.			

Other Connection Options	
*F	Female connection. Utilised when connection choices vary
*K	BSPT BS21, ISO7/1 - British Standard Taper Pipe thread
*R	BSPP BS2779 - British Standard Parallel Pipe thread
*RD	DIN 16284/16288/EN837 BSPP gauge connection type
SW*	ASME B16.11, EN12760 Female Socket Weld ⁶
*M2X	ISO Metric M20x1.5 Parallel Pipe thread - outlet option with Swivel Gauge connection (WG type)

* Insert connection size - Fem. thread is default.

⁶ As standard, valves with Female Socket Weld connections will be of the same length as per the equivalent NPT pipe threaded variants.

Butt Weld and Male Socket Weld - Pipe				
Type	Size	Schedule (Thickness)	Extension	
BW Butt Weld ⁷	4 1/4" NB 6 3/8" NB	A Sch.80 B Sch.160	* Default C 75mm	
MSW Male Socket Weld ⁸	8 1/2" NB 12 3/4" NB	B Sch.XXS	D 100mm	

⁷ As standard, valves with butt weld pipe connections will be of the same length as per the equivalent male NPT pipe threaded variants. Extended body dimensions are also offered - see tables and main catalogue.

⁸ As standard, valves with Male socket weld connections will have 1/2" (13mm) added to overall length (per connection) when compared to equivalent threaded valve. Extended body dimensions are also offered - see tables and main catalogue. Example: 3/4" NB male socket weld connection with Sch.XXS wall pipe and 100mm body extension = **MSW12BD**.

* No designator required when standard/default is selected/applied.

⁹ Examples:

- 10mm A-LOK inverted inlet/outlet & 1/4" NPT Fem. vent/drain = **IVAM104F**
- 10mm CPI inverted inlet/outlet & 1/4" NPT Fem. vent/drain = **IVZM104F**
- ¹⁰ PTFree connect™ option recommended for multi-port and single port gauge valve side ports, when a tube connection is required.

Examples:

- 10mm A-LOK tube stub con. inlet/outlet & 1/4" NPT Fem. vent/drain = **PFAM104F**
- 3/8" CPI male union con. inlet/outlet & 1/4" NPT Fem. vent/drain = **PFCZ164F**
- ¹¹ 1/4" NPT Fem. is default standard for bleed/vent/drain, some model types may be available with other connections

OPTIONS	
High Pressure - 10,000 PSI (689 bar) option	
HP	High Pressure ¹²
Gland Packing Options	
3	Graphite ¹³
FS	Firesafe design ¹⁴
Seating Options - Needle Valves only	
6S	6mm bore seat
RT	Regulating/Metering Tip
ST	Stellite Tip
9	PCTFE Soft Tip ¹⁵
PK	PEEK Soft Tip
Plug/Bleed Valve Options¹⁶	
P	Blank Plug
BV	Bleed Valve/Plug
PBV	Blank Plug and Bleed Valve/Plug
Operator Options	
HW	Handwheel
LHW	Handwheel Locking
THL	T Bar Locking
AT	Anti-Tamper ¹⁷
ATK	Anti-Tamper with Key ¹⁸
ATHKEY	Anti-Tamper Key ¹⁹
Mounting Options	
PM	Panel Mount
BM	Base Mount
BK	Assembled with Carbon Steel bracketry & bolts ²⁰
BKS	Assembled with Stainless Steel bracketry & bolts ²⁰
Other Options	
OX	Cleaned & lubricated for Oxygen use
NC	NACE MR-01-75 Compliant
M*	Assembly and Test of Free Issue Instrument

¹² Not necessary for HRPV models.

¹³ Not available for HRPV models. Not required when Firesafe design option (**FS**) selected.

¹⁴ Not available for PCTFE Soft tip (**9**), HRPV models or Oxygen cleaned product (**OX**).

¹⁵ 3,000 PSI/207 BAR only. See catalogue page 14.

¹⁶ Plugs supplied loose in a packing box. Typically required with multi-port gauge valves and single vent hand valves. See page 61.

¹⁷ Anti-Tamper operation and no key.

¹⁸ Anti-Tamper operation and one key supplied per manifold.

¹⁹ Anti-Tamper key. Specify quantity required as separate line item.

²⁰ Available on **HNVS** and **HGV** / **HGVWG** series only. Contact your local Parker representative for further support.

* Specify assembly and test option - see page 71. Gauge valves only.

IMPORTANT NOTES:

- For optimum results in integral tube connections on hand valves and gauge valves, the use of Parker pre-assembly tooling is highly recommended. For inverted style integral tube connections the use of Parker pre-assembly tooling is mandatory.
- Not all options/combinations are available in each single product model type.
- We reserve the right to review/revise this part number structure at any time. If necessary, we can refuse and/or recommend the most suitable alternative part number(s). We may also apply MOQ rules.
- Should your part number selection exceed 25 characters in length when completed, then it is likely to be incorrect, please consult your local Parker representation for assistance.
- If in any doubt, please consult your local Parker representation.

2-Valve Manifolds - H Series

Introduction

Combining two needle valves into one unitised block, the Parker 2-valve manifolds range is also referred to as Block and Bleed, Isolate and Calibrate or even Isolate and Vent/Drain. These manifolds are used primarily in applications requiring a pressure switch, pressure transmitter or gauge for Static Pressure Measurement. Other forms of sensing technology can be applied, and, in some circumstances, they can also be employed in the measurement of temperature or other process attribute.

In combination with Parker A-LOK® or CPI™ compression tube fitting technologies, a superior advantage is gained allowing users to eliminate threaded connections and reduce leak paths, whilst offering superior installation and operational performance.

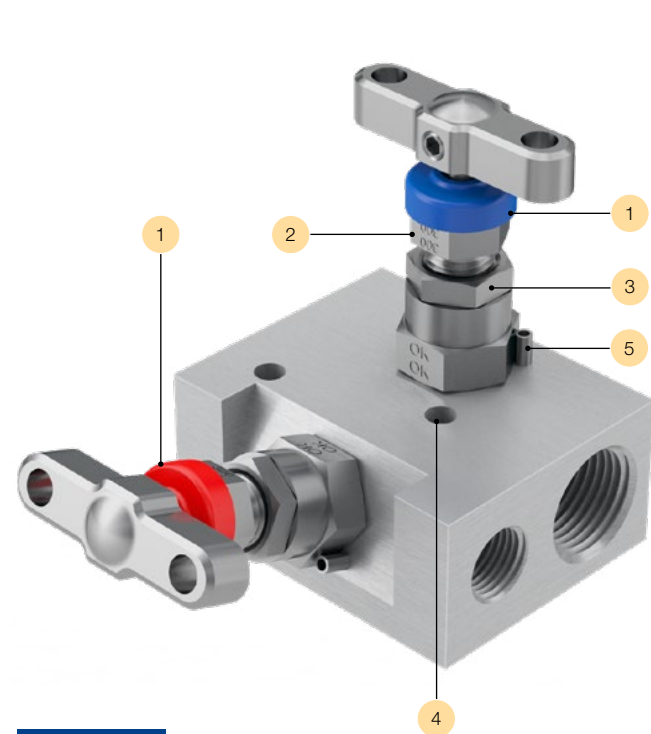

Reference	Description
1	Functional colour coded dust cap
2	Adjustable gland
3	Gland locknut
4	Bracket mounting holes
5	Bonnet locking pin

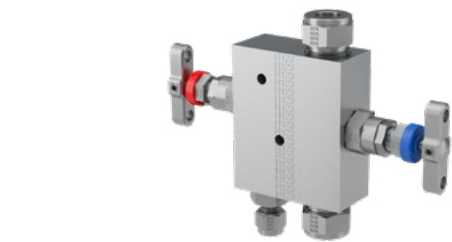

Example shown: 2-valve remote/line mount gauge valve, block and bleed (isolate and vent/drain) with Parker Superior Advantage fully integrated inverted A-LOK® tube fitting connections to inlet/outlet and Parker unique PTFree connect™ tube fitting connection to vent/drain.

We are confident you will find a manifold style, type and connection option to suit your applications, but should you require something different or need assistance to make your selection, please contact your local Parker support.



Example shown is application in use. HAL*WG 2-valve remote/line mount gauge valve manifold assembled to a Gauge Pressure Transmitter through the integral Swivel Adaptor described on page 31. A Parker Superior Advantage for flexibility of application in use.

- BLUE Isolate/block
- RED Drain/vent/test

These 2-valve manifolds are widely used in situations where a static pressure measurement device requires maintenance, offering safe isolation to allow venting/draining and calibration of the device. They also provide the means for removal and re-installation of an instrument in a live process situation. They are used in every industry in a wide range of applications - everywhere where accurate and secure pressure measurement of steam, air, gas, oil, water or other non-viscous liquids is required.

These manifolds are available in a remote (or line) mount and in a direct mount style for bolting to the face of static pressure transmitters with an array of input connection styles and types. The unique Parker superior advantage in this regard is being the ability to create a threadless leak-free hook up. Where additional operational security is required, a second isolate valve can be specified, thereby providing an enhanced Double Block and Bleed (DBB) solution.

2-Valve Manifolds - HNL Series

Remote/line mount - long pattern

Combining two needle valves into one unitised block, these slimline long pattern Parker 2-valve manifolds are also referred to as Block and Bleed, Isolate and Calibrate or Isolate and Vent/Drain. These manifolds are ideal for standalone line mounting.

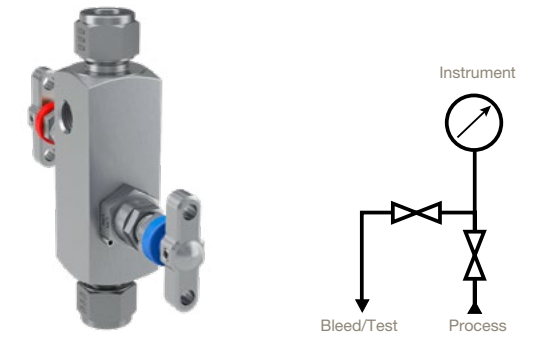

Example shown: 2-valve integral block and bleed manifold with integral A-LOK® connections.

HNL*2V - Male x Female threaded - NPT

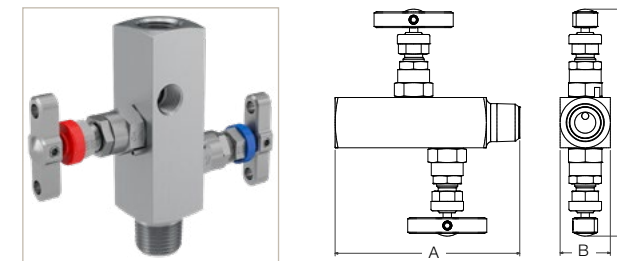

Pressure (PSI)	Inlet NPT	Outlet NPT	Vent NPT	Dimension		
				A mm (inch)	B mm (inch)	C mm (inch)
6,000	1/2" M	1/2" F	1/4" F	105.0 (4.13)	28.6 (1.13)	130.2 (5.13)
10,000	1/2" M	1/2" F	1/4" F	136.7 (5.38)	31.8 (1.25)	133.4 (5.25)

HNL*2V - Male x Male threaded - NPT

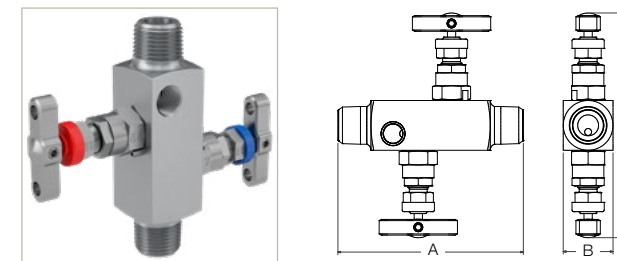

Pressure (PSI)	Inlet NPT	Outlet NPT	Vent NPT	Dimension		
				A mm (inch)	B mm (inch)	C mm (inch)
6,000	1/2" M	1/2" M	1/4" F	108.5 (4.27)	28.6 (1.13)	130.2 (5.13)
10,000	1/2" M	1/2" M	1/4" F	136.7 (5.38)	31.8 (1.25)	133.4 (5.25)

HNL*2V - Female x Female threaded - NPT

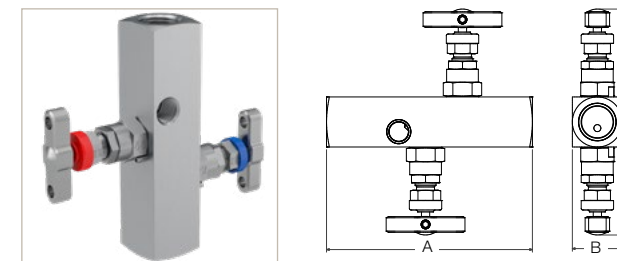

Pressure (PSI)	Inlet NPT	Outlet NPT	Vent NPT	Dimension		
				A mm (inch)	B mm (inch)	C mm (inch)
6,000	1/2" F	1/2" F	1/4" F	117.6 (4.63)	28.6 (1.13)	130.2 (5.13)
10,000	1/2" F	1/2" F	1/4" F	117.6 (4.63)	31.8 (1.25)	133.4 (5.25)

HNL*3DBB - Optional Double Block & Bleed threaded - NPT

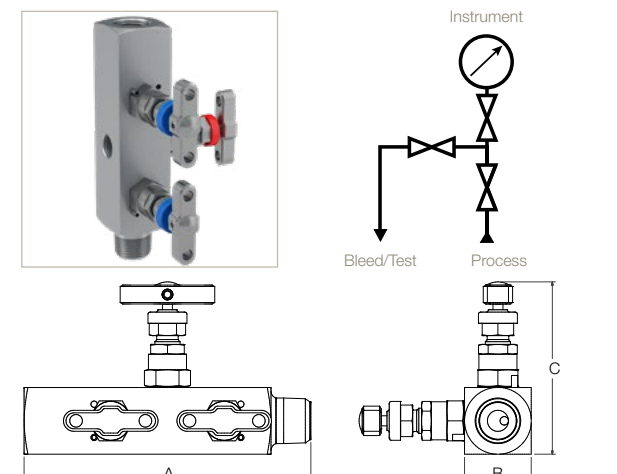

Pressure (PSI)	Inlet NPT	Outlet NPT	Vent NPT	Dimension		
				A mm (inch)	B mm (inch)	C mm (inch)
6,000	1/2" M	1/2" F	1/4" F	136.5 (5.37)	31.8 (1.25)	82.6 (3.25)
10,000	1/2" M	1/2" F	1/4" F	136.5 (5.37)	31.8 (1.25)	82.6 (3.25)
6,000	1/2" M	1/2" M	1/4" F	136.5 (5.37)	31.8 (1.25)	82.6 (3.25)
10,000	1/2" M	1/2" M	1/4" F	136.5 (5.37)	31.8 (1.25)	82.6 (3.25)
6,000	1/2" F	1/2" M	1/4" F	136.5 (5.37)	31.8 (1.25)	82.6 (3.25)
10,000	1/2" F	1/2" M	1/4" F	136.5 (5.37)	31.8 (1.25)	82.6 (3.25)

Products shown here can be supplied with integral swivel gauge adaptor as shown on page 31.

2-Valve Manifolds - H Series

Remote/line mount - short pattern

Combining two needle valves into one unitised flat block, this Parker 2-valve manifolds range is also referred to as a Block and Bleed, Isolate and Calibrate or even Isolate and Vent/Drain. These manifolds are ideal for robust mounting to bracket work or other structure.

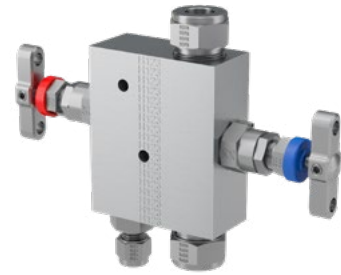

Example shown: 2-valve manifold with integral A-LOK® connections.

HL*2V - Female x Female threaded - NPT

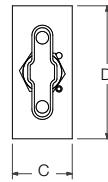
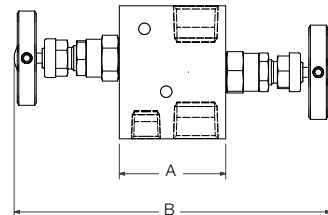
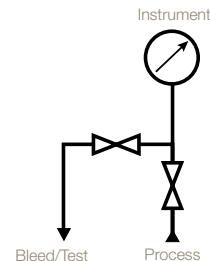

Pressure (PSI)	Inlet	Outlet	Bleed/Test	Dimension			
	NPT	NPT	NPT	A mm (inch)	B mm (inch)	C mm (inch)	D mm (inch)
6,000	1/2" F	1/2" F	1/4" F	50.8 (2.00)	152.4 (6.00)	28.6 (1.13)	63.5 (2.50)
10,000	1/2" F	1/2" F	1/4" F	50.8 (2.00)	152.4 (6.00)	31.8 (1.25)	69.8 (2.75)

HAL*2V - Female x Female threaded - NPT

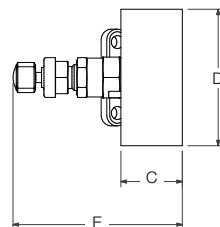
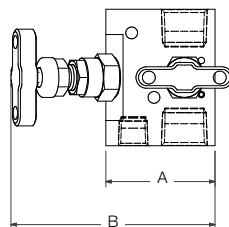
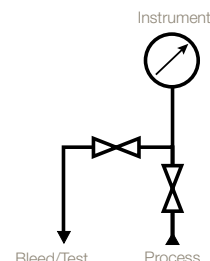

Pressure (PSI)	Inlet	Outlet	Bleed/Test	Dimension				
	NPT	NPT	NPT	A mm (inch)	B mm (inch)	C mm (inch)	D mm (inch)	E mm (inch)
6,000	1/2" F	1/2" F	1/4" F	50.8 (2.00)	100.5 (3.96)	28.6 (1.13)	63.5 (2.50)	79.4 (3.13)
10,000	1/2" F	1/2" F	1/4" F	63.5 (2.50)	114.3 (4.50)	31.8 (1.25)	69.8 (2.75)	82.6 (3.25)

HLTF*2V - Female x Female threaded - NPT

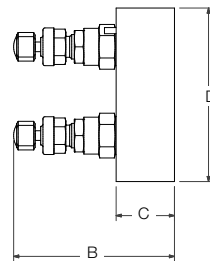
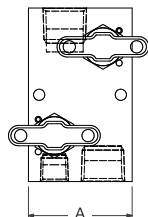
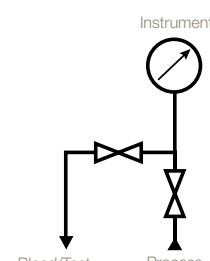

Pressure (PSI)	Inlet	Outlet	Bleed/Test	Dimension			
	NPT	NPT	NPT	A mm (inch)	B mm (inch)	C mm (inch)	D mm (inch)
6,000	1/2" F	1/2" F	1/4" F	50.8 (2.00)	79.4 (3.13)	28.6 (1.13)	85.0 (3.35)
10,000	1/2" F	1/2" F	1/4" F	55.7 (2.19)	82.6 (3.25)	31.8 (1.25)	88.9 (3.50)

HLLHV*2V - Female x Female threaded - NPT

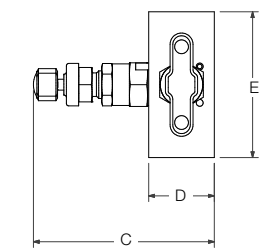
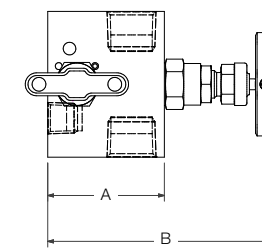
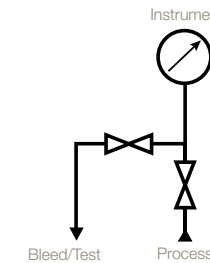
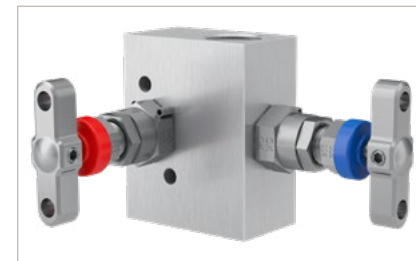

Pressure (PSI)	Inlet	Outlet	Bleed/Test	Dimension				
	NPT	NPT	NPT	A mm (inch)	B mm (inch)	C mm (inch)	D mm (inch)	E mm (inch)
6,000	1/2" F	1/2" F	1/4" F	50.8 (2.00)	101.6 (4.00)	79.4 (3.13)	28.6 (1.13)	63.5 (2.50)

HL*2V8M8F4F - Male x Female threaded - NPT

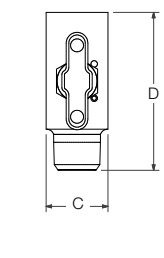
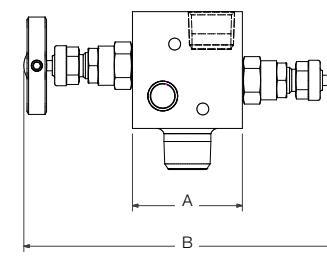
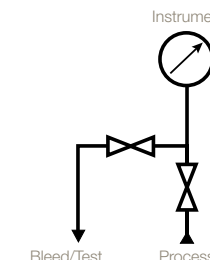

Pressure (PSI)	Inlet	Outlet	Bleed/Test	Dimension			
	NPT	NPT	NPT	A mm (inch)	B mm (inch)	C mm (inch)	D mm (inch)
6,000	1/2" M	1/2" F	1/4" F	50.8 (2.00)	152.4 (6.00)	28.6 (1.13)	73.0 (2.88)
10,000	1/2" M	1/2" F	1/4" F	50.8 (2.00)	152.4 (6.00)	31.8 (1.25)	76.2 (3.00)

HLWG*2V - Female threaded - NPT with integral swivel gauge adaptor

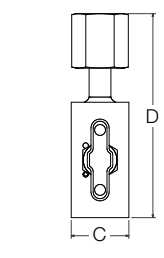
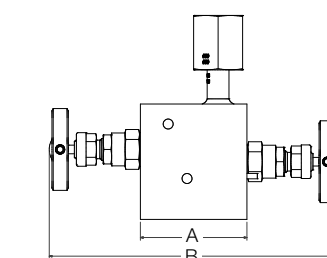
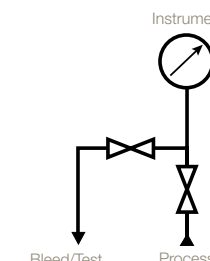
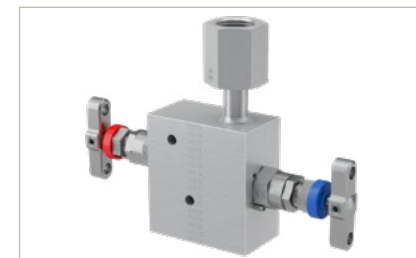

Pressure (PSI)	Inlet	Outlet	Bleed/Test	Dimension			
	NPT	BSPP*	NPT	A mm (inch)	B mm (inch)	C mm (inch)	D mm (inch)
6,000	1/2" F	1/2" F	1/4" F	50.8 (2.00)	152.4 (6.00)	28.6 (1.13)	112.0 (4.40)

*In accordance with DIN 16284 - Swivel BSPP 1/2" Female
 • Swivel adaptor to the outlet is provided through a socket weld, generally conforming to ANSI B16.11.
 • Weld connection is a "commercial weld", completed by a qualified welder. Any specific qualification, certification, documentation or additional NDT, will require to be engineered and quoted extra - please consult your local Parker support.
 • Union nut dimensions generally conform to DIN 16284 as it applies to the union of nipple and nut themselves.
 • Union nut also conforms generally to DIN EN 837 for the gauge connection itself, as it applies to the union of nipple and nut themselves.

HL*3DBB - Female threaded - NPT

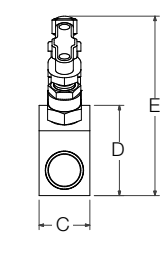
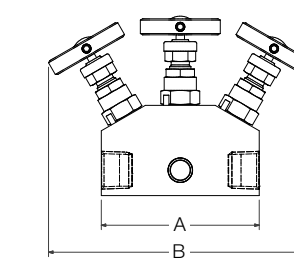
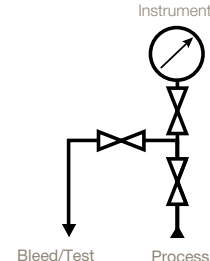

Pressure (PSI)	Inlet	Outlet	Bleed/Test	Dimension				
	NPT	NPT	NPT	A mm (inch)	B mm (inch)	C mm (inch)	D mm (inch)	E mm (inch)
6,000	1/2" F	1/2" F	1/4" F	88.9 (3.50)	148.3 (5.84)	28.6 (1.13)	50.8 (2.00)	101.6 (4.00)
10,000	1/2" F	1/2" F	1/4" F	88.9 (3.50)	148.6 (5.85)	31.8 (1.25)	57.2 (2.25)	107.7 (4.25)

2-Valve Manifolds - Remote/Line Mount

Ordering information

Example 1 (Default): **HLS2V**

Example 2: **HLS2V4RM8RF4F3P**

Example 3: **HNLWGS3DBB8M8R4FPOXNC**

Example 4: **HALS2VIVAM126ATK**

Example 5: **HNL6MO2VM12ATHLNC**

Example 6: **HLS3DBBIVZI84FPOX**

Example 7: **HL6MO3DBBIVAM12PFCAM6NC**

HL	S	2V		
HL	S	2V	4RM8RF4F	3P
HNLWG	S	3DBB	8M8R4F	POXNC
HAL	S	2V	IVM126	ATK
HNL	6MO	2V	M12A	THLNC
HL	S	3DBB	IVZI84F	POX
HL	6MO	3DBB	IVAM12PFCAM6	NC

- 2-valve block & bleed/isolate & calibrate/vent/drain, short pattern flat barstock manifold, manufactured from 316 Austenitic Stainless Steel material, having 1/2" NPT Fem. connection to both inlet & outlet and a 1/4" NPT fem. bleed/vent/drain connection. Gland packing is PTFE.
- 2-valve block & bleed/isolate & calibrate/vent/drain, long pattern flat barstock manifold, manufactured from 316 Austenitic Stainless Steel material, having 1/4" BSPP Male connection to inlet & 1/2" BSPP Fem. outlet with 1/4" NPT Fem. vent/drain connection. Gland packing is Graphite and a 1/4" NPT blanking plug is supplied.
- 3-valve block-bleed-block/double isolate & bleed/vent/drain, long pattern barstock manifold, manufactured from 316 Aust.St.St., with 1/2" NPT male inlet connection, 1/2" BSPP fem. outlet connection via integral welded swivel and 1/4" NPT fem. vent/drain/bleed. A 1/4" NPT blanking plug is supplied. Suitable for oxygen service and complies to NACE.
- 2-valve angle head block & bleed/isolate & calibrate/vent/drain, short pattern flat barstock manifold, 316 Aus.St.St. material with Parker Superior Advantage 12mm inverted tube con. to inlet and outlet. The bleed/vent/drain is also an inverted A-LOK tube con. suitable for 6mm tube. Gland packing is PTFE. Anti-Tamper operation and a single key.
- 2-valve block & bleed, long pattern manifold, manufactured from 6MO super austenitic stainless steel material with Parker A-LOK 12mm integral tube connections to inlet and outlet and 1/4" NPT fem. vent/drain/bleed. Manifold is also fitted with locking T bar handle operation and is compliant to NACE.
- 3-valve block-bleed-block/double isolate & calibrate vent/drain, flat barstock manifold manufactured from 316 Austenitic Stainless Steel material having Parker Superior 1/2" inverted integral CPI tube connections and a 1/4" NPT fem. vent/drain/bleed. Gland packing is PTFE. A 1/4" NPT blanking plug is supplied. Suitable for oxygen service.
- 3-valve block-bleed-block/double isolate & calibrate vent/drain, flat barstock manifold manufactured from 6MO Super Austenitic Stainless Steel material having Parker Superior Advantage 12mm inverted integral A-LOK tube connections to inlet and outlet with 6mm integral PTFree male union A-LOK tube connection to vent/drain/bleed. Gland packing is PTFE and the manifold complies to NACE.

Series	
HNL	Straight barstock gauge valves, long pattern
HNLWG	Straight barstock gauge valves, long pattern with Integral Swivel Gauge connection ¹
HL	Flat barstock gauge valves, short pattern
HLWG	Flat barstock gauge valves, short pattern with Integral Swivel Gauge connection ¹
HAL	Angled barstock gauge valves, short pattern
HALWG	Angled barstock gauge valves, short pattern with Integral Swivel Gauge connection ¹
HLLTF	Flat barstock gauge valves with valves on top face
HLLHV	Flat barstock gauge valves, short pattern with valves at 90 degree and left hand orientation

¹ Available as standard with 1/2" BSPP (8R); 1/4" BSPP (4R) by special request. Available only in 316SS. Consult your local Parker support for other potential material options.

Materials			
S	316/316L Stainless Steel	HC	Alloy C276
6MO	6MO Sup. Aust. St.Steel	T	Titanium Gr. 2 ²
M	Alloy M400 ²	825	Alloy 825
D1	Duplex 22 Cr. Steel	625	Alloy 625
D2	Super Duplex 25 Cr. Steel	C	Carbon Steel ³

² This material selection down-rates manifold.
³ For Carbon Steel consult your local Parker representation.

Application Configuration	
2V	2-valve, block and bleed/vent/drain, isolate and calibrate
3DBB	3-valve, double isolate and bleed/vent/drain, block-bleed-block ⁴
3DBB1	3-valve, double isolate and bleed/vent/drain, block-block-bleed ⁴

⁴ Available on **HL** and **HNL** series only.

Connections - Standard Options			
	Inlet	Outlet	Vent
*	1/2" NPT Fem.	1/2" NPT Fem.	1/4" NPT Fem.
4N	1/4" NPT Fem.	1/4" NPT Fem.	1/4" NPT Fem.
4K	1/4" BSPT Fem.	1/4" BSPT Fem.	1/4" BSPT Fem.
4R	1/4" BSPP Fem.	1/4" BSPP Fem.	1/4" BSPP Fem.
8K	1/2" BSPT Fem.	1/2" BSPT Fem.	1/4" BSPT Fem.
8R	1/2" BSPP Fem.	1/2" BSPP Fem.	1/4" BSPP Fem.
4M4F4F	1/4" NPT Male	1/4" NPT Fem.	1/4" NPT Fem.
8M8F4F	1/2" NPT Male	1/2" NPT Fem.	1/4" NPT Fem.
12M8F4F	3/4" NPT Male	1/2" NPT Fem.	1/4" NPT Fem.
4A	1/4" A-LOK ⁵	1/4" A-LOK ⁵	1/4" NPT Fem.
6A	3/8" A-LOK ⁵	3/8" A-LOK ⁵	1/4" NPT Fem.
8A	1/2" A-LOK ⁵	1/2" A-LOK ⁵	1/4" NPT Fem.
M6A	6mm A-LOK ⁵	6mm A-LOK ⁵	1/4" NPT Fem.
M10A	10mm A-LOK ⁵	10mm A-LOK ⁵	1/4" NPT Fem.
M12A	12mm A-LOK ⁵	12mm A-LOK ⁵	1/4" NPT Fem.

* Default connection, no designator required.

⁵ Available on **HNL** series only. For CPI™ (single ferrule tube fitting) connection change **A** to **Z**. 1/4" NPT Fem. is default standard, some model types may be available with other connections.

Other Connection Options ⁶	
*F	Fem. NPT connection. Utilise for non-default selections
*M	Male NPT connection. Utilise for non-default selections
*#F	Fem. connection. Utilise when connections and specifications vary
*#M	Male connection. Utilise when connections and specifications vary
K	BSPT BS21, ISO7/1 - British Standard Taper Pipe thread
R	BSPP BS2779 - British Standard Parallel Pipe thre
RD	DIN 16284/16288/EN837 BSPP gauge connection type
SW*	ASME B16.11, EN12760 Female Socket Weld ⁷
*M2X	ISO Metric M20x1.5 Parallel Pipe thread - outlet option with Swivel Gauge connection (WG type)

⁶ Default standard manifolds require no additional designators. Example: 1/2" NPT Fem. inlet & 1/2" NPT Fem. outlet & 1/4"NPT Fem. vent = **HL*2V** (as example above). As connection choices vary, all connections must be designated. **Examples:**
 • 1/4" NPT Male (**4M**) inlet, 1/2" NPT Fem. (**8F**) outlet, 1/4" NPT Fem. vent (**4F**) = **4M8F4F**
 • 1/2"BSPP Fem. (**8RF**) inlet & 1/2"BSPP Fem. (**8RF**) outlet & 1/4"NPT Fem. vent (**4F**) = **8RF8RF4F**
 • 1/2"BSPP Fem. (**8RF**) inlet & 1/2"BSPP Fem. (**8RF**) outlet & 1/4"BSPT Fem. (**4KF**) vent = **8RF8RF4KF**

* Insert size designator.
Insert specification (**K/R/RD**).

⁷ As standard, valves with Female Socket Weld connections will be of the same length as per the equivalent NPT pipe threaded variants.

⁸ Available on **HNL** series only.
⁹ No designator required.

⁹ As standard, valves with butt weld pipe connections will be of the same length as per the equivalent male NPT pipe threaded variants. Extended body dimensions are also offered - see tables and main catalogue.

¹⁰ As standard, valves with Male Socket Weld conn. will have 1/2" (13mm) added to overall length (per connection) when compared to equivalent threaded valve. Extended body dimensions are also offered - see tables and main catalogue. **Example:** 3/4" NB male socket weld conn. with Sch.XXS wall pipe and 100mm body extension = **MSW12BD**.

¹¹ **Examples:**
 • 10mm A-LOK inverted inlet/outlet & 1/4" NPT Fem. vent/drain = **IVAM104F**
 • 10mm CPI inverted inlet/outlet & 1/4" NPT Fem. vent/drain = **IVZM104F**

¹² **Examples:**
 • 10mm A-LOK tube stub con. inlet/outlet & 1/4" NPT Fem. vent/drain = **PFAM104F**
 • 3/8" CPI male union con. inlet/outlet & 1/4"NPT Fem. vent/drain = **PFCZI64F**

¹³ 1/4" NPT Fem. is default standard for bleed/vent/drain, some model types may be available with other connections

OPTIONS	
High Pressure - 10,000 PSI (689 bar) option	
HP	High Pressure
Gland Packing Options	
3	Graphite ¹⁴
FS	Firesafe design ¹⁵
Seating Options - Needle Valves only	
6S	6mm bore seat ¹⁶
RT	Regulating/Metering Tip
ST	Stellite Tip
9	PCTFE Soft Tip ¹⁷
PK	PEEK Soft Tip
Plug/Bleed Valve Options¹⁸	
P	Blank Plug
BV	Bleed Valve/Plug
Operator Options¹⁹	
HW	Handwheel for all valves
LHW	Handwheel Locking for all valves
THL	T Bar Locking for all valves
AT	Anti-Tamper for all valves ²⁰
ATK	Anti-Tamper for all valves with Key ²¹
ATHKEY	Anti-Tamper Key ²²
Mounting Options	
BK	Assembled with Carbon Steel bracketry & bolts
BKS	Assembled with Stainless Steel bracketry & bolts
Other Options	
OX	Cleaned & lubricated for Oxygen use
NC	NACE MR-01-75 Compliant
M*	Assembly and Test of Free Issue Instrument

¹⁴ Not required when Firesafe design option (**FS**) selected.

¹⁵ Not available for PCTFE Soft Tip (**9**) or Oxygen use (**OX**).

¹⁶ 6mm bore seat and other flow passages not available on all selections. Please consult your local Parker support.

¹⁷ 3,000 PSI/207 BAR only. See catalogue page 14.

¹⁸ Plugs supplied loose in a packing box. See page 61.

¹⁹ These options can be specified to independent valves: Add **I** to specify specify assembly to Isolate valves. Add **V** to specify specify assembly to Vents/Drains/Bleeds. Examples:

- **ATI** = Anti-Tamper to Isolate valve.
- **HWV** = Handwheel to Vents/Drains/Bleeds.

²⁰ Anti-Tamper operation and no Key.

²¹ Anti-Tamper operation and one Key supplied per manifold.

²² Specify quantity required as separate line item.

* Specify assembly and test option - see page 71.

IMPORTANT NOTES:

- For optimum results in integral tube connections on manifolds, the use of Parker pre-assembly tooling is highly recommended. For inverted style integral tube connections the use of Parker pre-assembly tooling is mandatory.
- Not all options/combinations are available in each single product model type.
- We reserve the right to review/revise this part number structure at any time. If necessary, we can refuse and/or recommend the most suitable alternative part number(s). We may also apply MOQ rules.
- Should your part number selection exceed 25 characters in length when completed, then it is likely to be incorrect, please consult your local Parker representation for assistance.
- If in any doubt, please consult your local Parker representation.

Mounting Brackets

Brackets for remote/line mount manifolds and gauge valves

It is essential to fully support impulse/pressure measurement tubing lines, manifolds and instruments. For this reason, all Parker manifolds are designed to accommodate bracket mounting and support.

needed to efficiently operate all handles and are also designed to offer maximum rigidity and support in horizontal or vertical orientations on panels, walls or 2" NB pipe stands.

A full range of bracket mounting kits can be supplied fully assembled to the manifolds, or supplied separately for on-site installation. Available in either all carbon or all stainless steel, they are specifically matched to Parker manifolds to ensure the clearance

Parker is also able to offer all other items necessary to complete your installations, including the 2"NB pipe stands, tubing clamps, cable/tube trays, populated enclosure solutions and much more. For further information please contact your local Parker support.

Brackets for 2-valve remote mount manifolds - BKT1



Image shown: Part No.: HLS2VBK

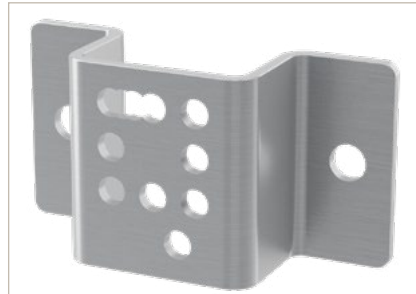
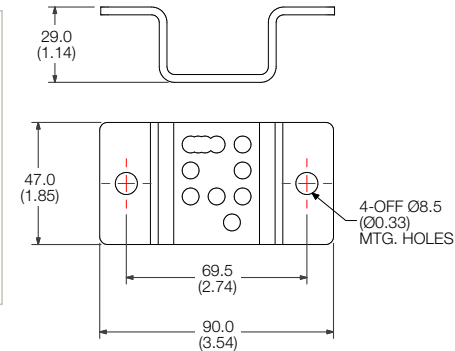

Image shown: Part No.: BKT1SSB1



How to order:

Item	Part Number		Suitable for Manifold Type
	Bracket material: Carbon Steel	Bracket material: Stainless Steel	
Bracket with M8 'U' Bolt and manifold Bolt Kit (Nuts and washers: M5 x 45 Bolt (2-OFF))	BKT1CSB1	BKT1SSB1	HL*2V HL*2V8M8F4F HAL*2V HLLHV*2V

Brackets for 2-valve remote mount manifolds and 3-valve DBB manifolds - BKT2

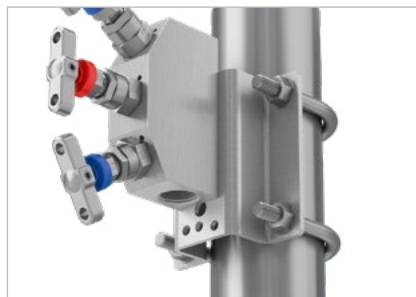
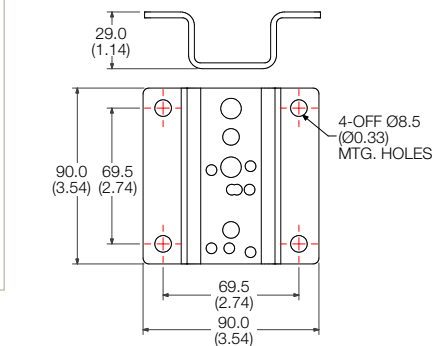

Image shown: Part No.: HLS3DBBBK



Image shown: Part No.: BKT2SSB2



How to order:

Item	Part Number		Suitable for Manifold Type
	Bracket material: Carbon Steel	Bracket material: Stainless Steel	
Bracket with M8 'U' Bolts and manifold Bolt Kit (Nuts and washers: M5 x 45 Bolt (2-OFF))	BKT2CSB1	BKT2SSB1	HAL*2VHP HLTF*2V
Bracket with M8 'U' Bolts and manifold Bolt Kit (Nuts and washers: M10 x 12 Bolt (2-OFF))	BKT2CSB2	BKT2SSB2	HL*3DBB HL*3DBB1

'U' bolt with nuts and washers for 2" NB standpipe



Bracket kits include U bolts with nuts and washers.

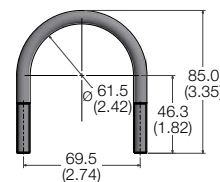

3 and 5-Valve Manifolds - H Series

Introduction

Combining three or five bonnet assemblies into one block, this Parker 3 and 5-valve manifolds range is primarily used in applications requiring Differential Pressure Transmitters, Gauges and/or Chart Recorders mainly for the purpose of flow measurement. In some circumstances, differential pressure measurement will also be used in other applications, such as level or filtration.

In combination with Parker A-LOK® or CPI™ compression tube fittings and PTFree connect™ technologies, a superior advantage is gained allowing users to eliminate threaded connections and reduce leak paths, whilst offering superior installation and operational performance.

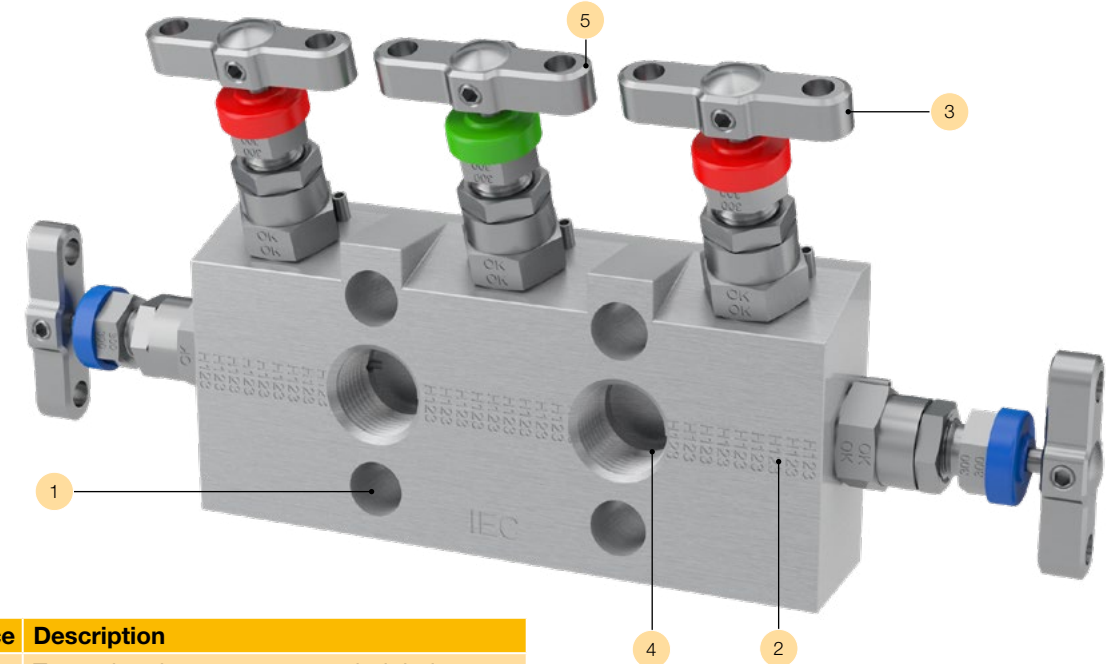

Reference	Description
1	Transmitter instrument mount bolt holes
2	Material heat code traceability
3	Ergonomic T-bar operator
4	Process inlet connection
5	Transmitter equalise valve

BLUE	Isolate/block
RED	Drain/vent/test
GREEN	Equalise

These manifolds are widely used in situations where a differential pressure measurement device requires maintenance, offering safe isolation to allow venting/draining and calibration of that device. They also provide the means for removal and re-installation of an instrument in a live process situation. They are used in every industry in a wide range of applications - everywhere where accurate and secure pressure measurement of steam, air, gas, oil, water or other non-viscous liquids is required.

We are confident you will find a manifold style, type and connection option to suit your applications, but should you require something different or need assistance to make your selection, please contact your local Parker support.

These manifolds are available in a remote (or line) mount and in a direct mounting style for bolting directly to the face of Differential Pressure Transmitters with an array of input connection styles and types. The unique Parker superior advantage in this regard is being the ability to create a threadless leak-free hook up. Where additional operational security or functionality is required, a number of differing flow path configurations and additional ports are available to allow purging upstream or downstream of the isolation valves.



Example shown: 3-valve direct mount manifold with NPT connections and additional test/purge ports.

3-Valve Manifolds - H Series

Remote/line mount

These 3-valve remote mount manifolds combine three needle valves into one unitised block to create Isolation for the instrument impulse lines and an Equalisation feature to assist in installation and maintenance of the remotely connected instrument(s). They are truly flexible having a multitude of available connection options.



Example shown: 3-valve remote/line mount manifold featuring the Parker A-LOK® Superior Advantage inverted integral tube fitting connections.

HL*3M - Female x Female threaded - NPT

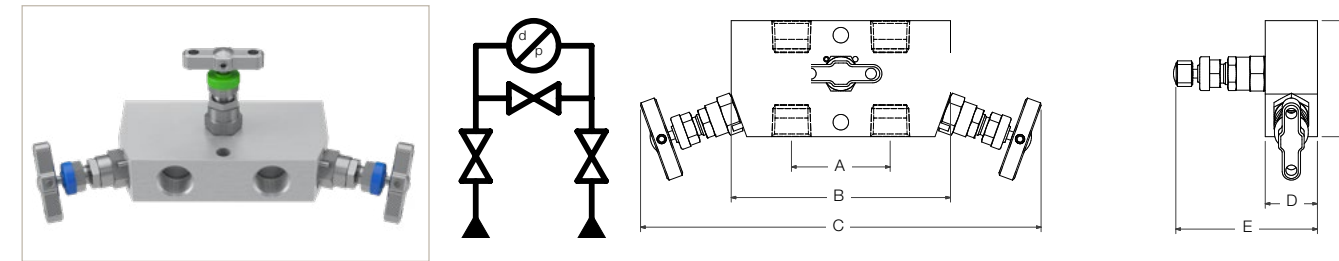

Pressure PSI	Inlet	Outlet	Dimension					
			A mm (inch)	B mm (inch)	C mm (inch)	D mm (inch)	E mm (inch)	F mm (inch)
6,000	1/2" NPT	1/2" NPT	54.0 (2.125)	120.0 (4.72)	220.0 (8.66)	28.6 (1.13)	79.4 (3.13)	63.5 (2.50)
10,000	1/2" NPT	1/2" NPT	54.0 (2.125)	132.0 (5.20)	232.0 (9.14)	31.8 (1.25)	82.6 (3.25)	63.5 (2.50)

HL*3MDTP - Female x Female threaded - NPT with downstream test ports

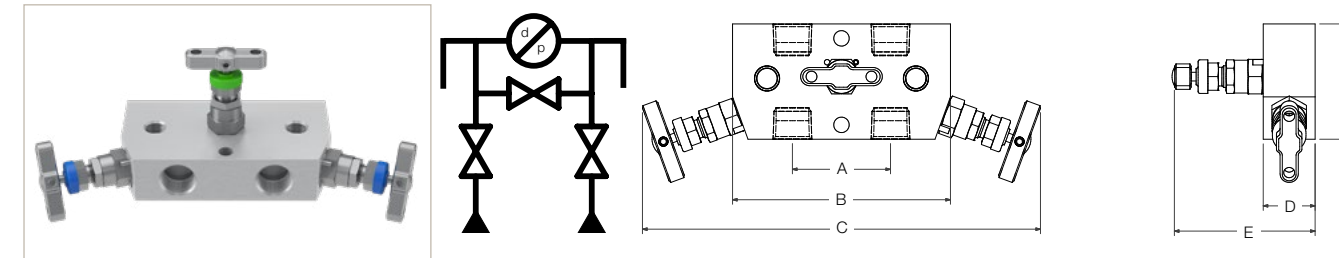

Pressure PSI	Inlet	Outlet	Drain/Bleed/Test	Dimension					
				A mm (inch)	B mm (inch)	C mm (inch)	D mm (inch)	E mm (inch)	F mm (inch)
6,000	1/2" NPT	1/2" NPT	1/4" NPT	54.0 (2.125)	120.0 (4.72)	220.0 (8.66)	28.6 (1.13)	79.4 (3.13)	63.5 (2.50)

HL*3MUPP - Female x Female threaded - NPT with upstream purge ports

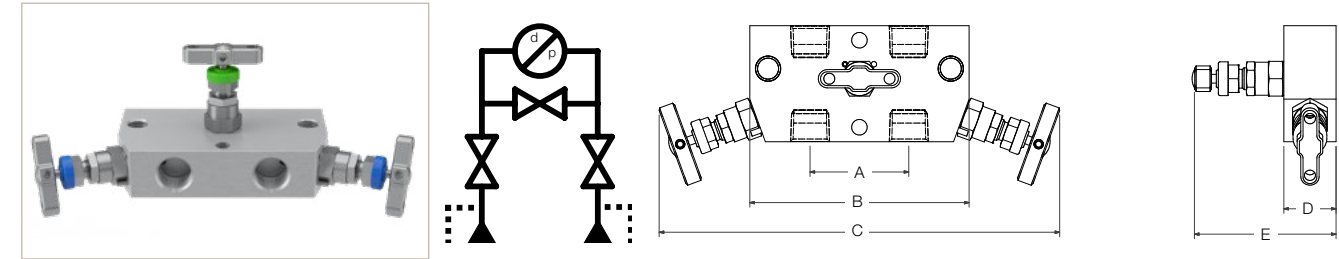

Pressure PSI	Inlet	Outlet	Drain/Bleed/Test	Dimension					
				A mm (inch)	B mm (inch)	C mm (inch)	D mm (inch)	E mm (inch)	F mm (inch)
6,000	1/2" NPT	1/2" NPT	1/4" NPT	54.0 (2.125)	120.0 (4.72)	220.0 (8.66)	28.6 (1.13)	79.4 (3.13)	63.5 (2.50)

5-Valve Manifolds - H Series

Remote/line mount

These 5-valve remote mount manifolds combine five needle valves into one unitised block to create Isolation for the instrument impulse lines and an Equalisation feature to assist in installation and maintenance of the remotely connected instrument(s). They also incorporate vent/drain or calibration valves and ports. These manifolds are truly flexible, having a multitude of available connection options and are suitable for use in many applications including those utilising Differential Pressure Gauges.



Example shown: 5-valve remote/line mount manifold featuring the Parker A-LOK® Superior Advantage inverted integral tube fitting connections for the impulse line and NPT ported connections for the vent/drain.

HL*5M - Female x Female threaded - NPT

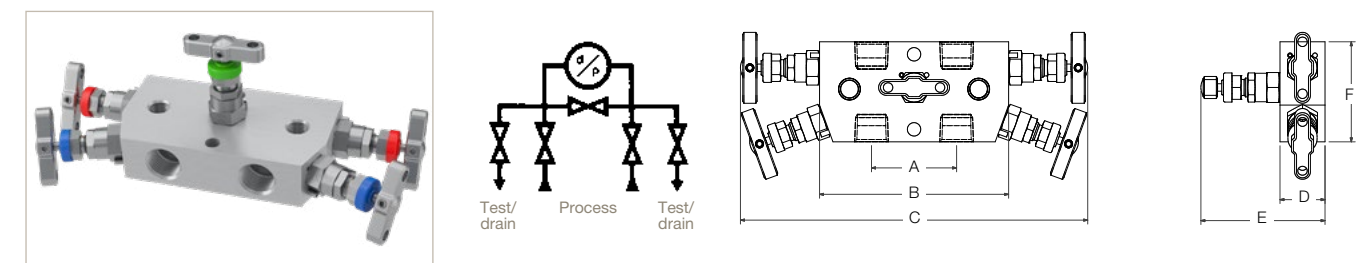

Pressure PSI	Inlet	Outlet	Bleed /test	Dimension					
				A mm (inch)	B mm (inch)	C mm (inch)	D mm (inch)	E mm (inch)	F mm (inch)
6,000	1/2" NPT	1/2" NPT	1/4" NPT	54.0 (2.125)	120.0 (4.72)	221.6 (8.72)	28.6 (1.13)	79.4 (3.13)	63.6 (2.50)
10,000	1/2" NPT	1/2" NPT	1/4" NPT	54.0 (2.125)	132.0 (5.20)	233.6 (9.20)	31.8 (1.25)	82.6 (3.25)	76.2 (3.00)

HL*5MCT - Female x Female threaded - NPT

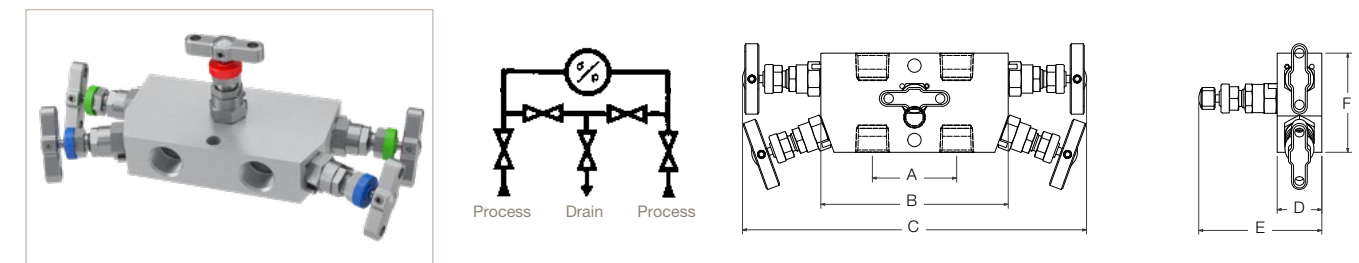

Pressure PSI	Inlet	Outlet	Bleed /test	Dimension					
				A mm (inch)	B mm (inch)	C mm (inch)	D mm (inch)	E mm (inch)	F mm (inch)
6,000	1/2" NPT	1/2" NPT	1/4" NPT	54.0 (2.125)	120.0 (4.72)	221.6 (8.72)	28.6 (1.13)	79.4 (3.13)	63.6 (2.50)

3 and 5-Valve Manifolds - Remote/Line Mount

Ordering information

Example 1 (Default): **HLS5M**

Example 2: **HL6MO3M4NHPPATEBKSN**

Example 3: **HL6MO3MUPPPFAI44PKPOX**

Example 4: **HLS5MSW83PATKVBKNC**

Example 5: **HLS5MCTPFCAM126ATKE**

Example 6: **HL6MO5MIVAM12PFCAM6**

HL	S	5M		
HL	6MO	3M	4N	HPPATEBKSN
HL	6MO	3MUPP	PFAI44	PKPOX
HL	S	5M	SW8	3PATKVBKNC
HL	S	5MCT	PFCAM126	ATKE
HL	6MO	5M	IVAM12	PFCAM6

- 5-valve remote mount, thread to thread 6,000 PSI manifold, manufactured from 316 Stainless Steel material having 1/2" NPT Fem. connections to inlets and outlets with 1/4" NPT Fem. connections to vents. Gland packing is PTFE.
- 3-valve remote mount, thread to thread 10,000 PSI manifold, manufactured from 6MO material having 1/4" NPT Fem. connections to inlets and outlets. Gland packing is PTFE. Manifold has Anti-tamper operation to the equalise valve, is fitted to a stainless steel mounting bracket assembly and complies to NACE.
- 3-valve remote mount, tube to tube manifold, manufactured from 6MO material having 1/4" A-LOK PTFree tube stub con. to inlets and outlets. There are 2 additional 1/4" NPT Fem. upstream test ports - 1/4" NPT blanking plugs supplied. Gland packing is PTFE. Valves are fitted with PEEK soft tip stems; manifold is cleaned suitable for oxygen service.
- 5-valve remote mount, 6,000 PSI manifold manufactured from 316 SS material having 1/2" NB Fem. socket weld con. to inlets and outlets with 1/4" NPT Fem. vent ports. Gland packing is Graphite. Manifold also includes Anti-tamper operation to the vent valves, is fitted with a Carbon S mounting bracket assembly and complies to NACE. One Anti-tamper key and two 1/4" NPT blanking plugs are also supplied.
- 5-valve remote mount manifold manufactured from 316 SS having Parker Superior advantage 12mm A-LOK PTFree male union con. to inlets and outlets with 6mm PTFree male union con. to the vents/drains/bleeds. Gland packing is PTFE. Manifold is fitted with Anti-tamper operation to the equalise valve and supplied with one Anti-tamper key.
- 5-valve remote mount, tube to tube manifold, manufactured from 6MO Aust. Stainless Steel material having Parker Superior Advantage 12mm A-LOK inverted tube connections to inlets and outlets with 6mm A-LOK PTFree male union connections to the vents. Gland packing is PTFE.

Series			
HL	Flat barstock remote/line mount/pipe to pipe/thread to thread manifolds		
Materials			
S	316/316L Stainless Steel	HC	Alloy C276
6MO	6MO Sup. Aust. St.Steel	T	Titanium Gr. 2 ¹
M	Alloy M400 ¹	825	Alloy 825
D1	Duplex 22 Cr. Steel	625	Alloy 625
D2	Super Duplex 25 Cr. Steel	C	Carbon Steel ²

¹ This material selection down-rates manifold.

² For Carbon Steel consult your local Parker representation.

Application Configuration	
3M	3-valve, isolate and equalise
3MDTP	3-valve, isolate and equalise with downstream vent/drain/bleed/test ports
3MUPP	3-valve, isolate and equalise with upstream purge ports
5M	5-valve, isolate, equalise with vent/test/bleed
5MCT	5-valve, isolate, equalise with vent/test/bleed suitable for Custody Transfer applications

Connections - Standard Options			
	Inlet	Outlet	Vent
*	1/2" NPT Fem.	1/2" NPT Fem.	1/4" NPT Fem.
4N	1/4" NPT Fem.	1/4" NPT Fem.	1/4" NPT Fem.
4K	1/4" BSPT Fem.	1/4" BSPT Fem.	1/4" BSPT Fem.
4R	1/4" BSPP Fem.	1/4" BSPP Fem.	1/4" BSPP Fem.
8K	1/2" BSPT Fem.	1/2" BSPT Fem.	1/4" BSPT Fem.
8R	1/2" BSPP Fem.	1/2" BSPP Fem.	1/4" BSPP Fem.
SW8	1/2" NB Fem. SW ³	1/2" NB Fem. SW ³	1/4" NPT Fem.

* Default connection, no designator required. Default standard manifolds require no additional designators. Example: 1/2" NPT Fem. inlet & 1/2" NPT Fem. outlet & 1/4" NPT Fem. vent = **HL*5M** (as above) As connection choices vary, all connections must be designated. **Examples:**

- 1/2" BSPP Fem. inlet & 1/2" BSPP Fem. outlet & 1/4" NPT Fem. vent = **8R4F**
- 1/2" BSPP Fem. inlet & 1/2" BSPP Fem. outlet & 1/4" BSPT Fem. vent = **8R4K**

³ As standard, valves with Female Socket Weld connections will be of the same length as per the equivalent NPT pipe threaded variants.

Optional Connections				
Type	Fitting	Unit	Inlet/Outlet	Bleed/Vent/Drain
IV	Inverted Connection Tube OD ⁴	M Metric	6 6mm	4F 1/4" NPT ⁶
PF	PTFree connect tube stub ⁵		10 10mm	
PFC	PTFree connect male union ⁵	I Imperial	12 12mm	
			4 1/4"	
			6 3/8"	
			8 1/2"	

⁶ 1/4" NPT Fem. is default standard for bleed/vent/drain, some model types may be available with other connections.

OPTIONS	
High Pressure - 10,000 PSI (689 bar) option	
HP	High Pressure
Gland Packing Options	
3	Graphite ⁷
FS	Firesafe design ⁸
Seating Options - Needle Valves only	
6S	6mm bore seat ⁹
RT	Regulating/Metering Tip
ST	Stellite Tip
9	PCTFE Soft Tip ¹⁰
PK	PEEK Soft Tip
Plug/Bleed Valve Options¹¹	
P	Blank Plug
BV	Bleed Valve/Plug
PBV	Blank Plug and Bleed Valve/Plug
Operator Options¹²	
HW	Handwheel for all valves
LHW	Handwheel Locking for all valves
THL	T Bar Locking for all valves
AT	Anti-Tamper for all valves ¹³
ATK	Anti-Tamper for all valves with Key ¹⁴
ATHKEY	Anti-Tamper Key ¹⁵
Mounting Options	
BK	Assembled with Carbon Steel bracketry & bolts
BKS	Assembled with Stainless Steel bracketry & bolts
Other Options	
OX	Cleaned & lubricated for Oxygen use
NC	NACE MR-01-75 Compliant
M*	Assembly and Test of Free Issue Instrument

⁷ Not required when Firesafe design option (**FS**) selected.

⁸ Not available for PCTFE Soft Tip (**9**) or Oxygen use (**OX**).

⁹ 6mm bore seat and other flow passages not available on all selections. Please consult your local Parker support.

¹⁰ 3,000 PSI/207 BAR only. See main catalogue page.

¹¹ Plugs supplied loose in a packing box. See page 61.

¹² These options can be specified to independent valves:

Add **E** to specify assembly to Equalise valve only.
Add **I** to specify assembly to Isolate valves.
Add **V** to specify assembly to Vents/Drains/Bleeds.
Examples:

- **HWV** = Handwheel to Vents/Drains/Bleeds.
- **ATE** = Anti-Tamper to Equalise valve.

¹³ Anti-Tamper operation and no Key.

¹⁴ Anti-Tamper operation and one Key supplied per manifold.

¹⁵ Specify quantity required as separate line item.

* Specify assembly and test option - see page 71.

IMPORTANT NOTES:

- For optimum results in integral tube connections on manifolds, the use of Parker pre-assembly tooling is highly recommended. For inverted style integral tube connections the use of Parker pre-assembly tooling is mandatory.
- Not all options/combinations are available in each single product model type.
- We reserve the right to review/revise this part number structure at any time. If necessary, we can refuse and/or recommend the most suitable alternative part number(s). We may also apply MOQ rules.
- Should your part number selection exceed 25 characters in length when completed, then it is likely to be incorrect, please consult your local Parker representation for assistance.
- If in any doubt, please consult your local Parker representation.

Mounting Brackets

Brackets for remote/line mount manifolds and gauge valves

Brackets for 3 and 5-valve remote mount manifolds - BKT2

- Universal manifold mounting bracket, suitable for all remote mount manifolds
- Allows 90 degree positioning enabling total installation flexibility and prevents handle obstruction
- Can be wall, standpipe or base mounted

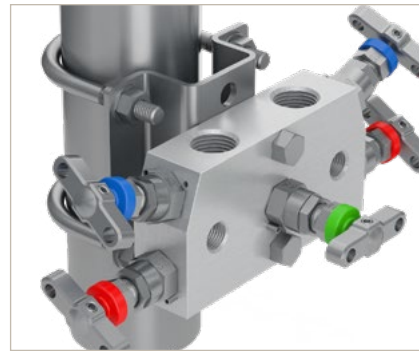
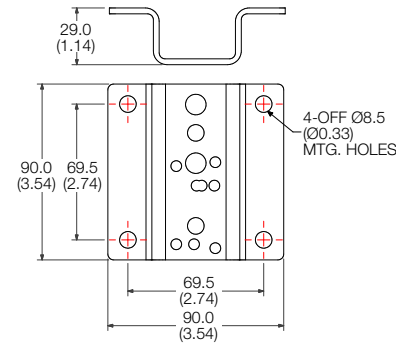

Image shown: Part No.: HLS5MBK



Image shown: Part No.: BKT2SSB5



How to order:

Item	Part Number		Suitable for Manifold Type
	Bracket material: Carbon Steel	Bracket material: Stainless Steel	
Bracket with M8 'U' Bolt and manifold Bolt Kit (Nuts and washers: M8 x 45 Bolt (2-OFF))	BKT2CSB5	BKT2SSB5	HL*3M HL*3MDTP HL*5M HL*5MHP

'U' bolt with nuts and washers for 2" NB standpipe



Bracket kits include U bolts with nuts and washers.

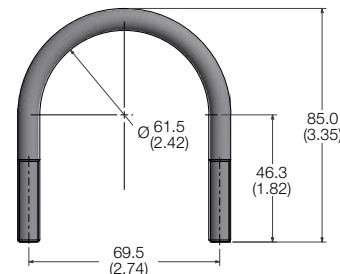

2-Valve Manifolds - H Series

Direct mount

Combining two needle valves into one unitised block, this 2-valve manifolds range is also referred to as a Block and Bleed, Isolate and Calibrate or even Isolate and Vent/Drain. These manifolds are specifically designed for direct connection to absolute/gauge pressure transmitters, having bolted interface conforming to DIN/IEC 61518 Type B as standard, and type A available by request. With additional mounting holes and a wide range of bracketry, these manifolds can also be utilised as support for the instrument within any installation.

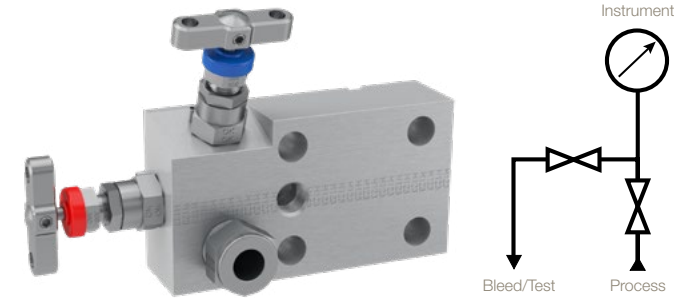

Example shown: 2-valve manifold with inverted integral A-LOK® connections.

HD*2M - Female threaded - NPT x Flanged

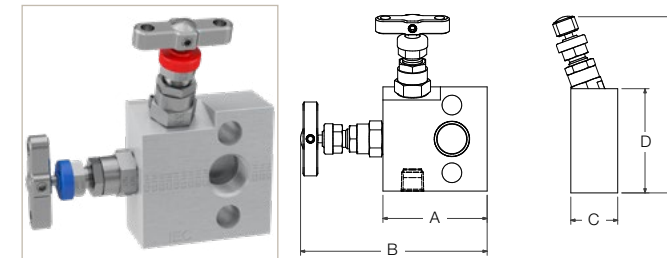

Pressure (PSI)	Inlet	Outlet	Bleed /test	Dimension				
				A mm (inch)	B mm (inch)	C mm (inch)	D mm (inch)	E mm (inch)
6,000	1/2" NPT	Flanged	1/4" NPT	63.5 (2.50)	114.3 (4.50)	28.6 (1.13)	63.5 (2.50)	107.6 (4.24)

HD*2MFD variant available with vent/bleed/drain connection on same face as process inlet.

HD*2MFF - Flanged x Flanged (straight through bolted flange)

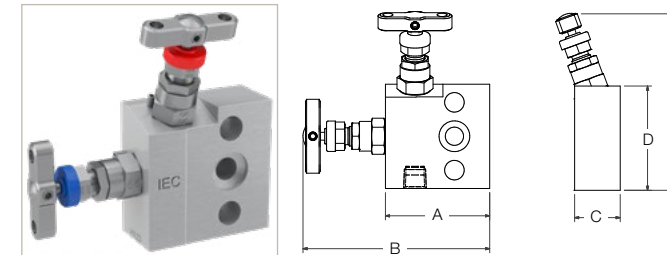

Pressure (PSI)	Inlet	Outlet	Bleed /test	Dimension				
				A mm (inch)	B mm (inch)	C mm (inch)	D mm (inch)	E mm (inch)
6,000	Flanged	Flanged	1/4" NPT	63.5 (2.50)	114.3 (4.50)	28.6 (1.13)	63.5 (2.50)	107.6 (4.24)

HEH*2 - Flanged x Flanged

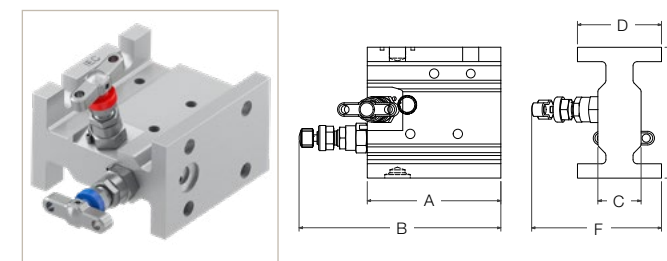

Pressure (PSI)	Inlet	Outlet	Bleed /test	Dimension					
				A mm (inch)	B mm (inch)	C mm (inch)	D mm (inch)	E mm (inch)	F mm (inch)
6,000	Flanged	Flanged	1/4" NPT	98.5 (3.88)	149.3 (5.88)	31.8 (1.25)	62.0 (2.44)	96.4 (3.80)	95.8 (3.77)

HEH*2 manifolds are available in 316/316L Stainless Steel material only.

HET*2 - Female threaded - NPT x Flanged

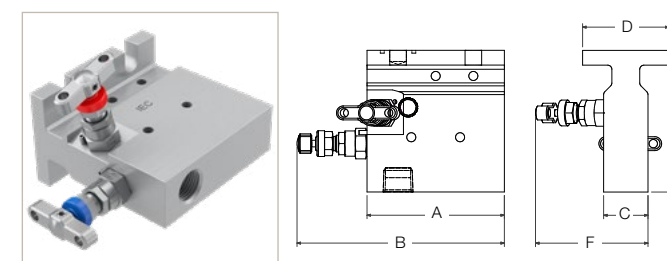

Pressure (PSI)	Inlet	Outlet	Bleed /test	Dimension					
				A mm (inch)	B mm (inch)	C mm (inch)	D mm (inch)	E mm (inch)	F mm (inch)
6,000	1/2" NPT	Flanged	1/4" NPT	98.5 (3.88)	149.3 (5.88)	31.8 (1.25)	62.0 (2.44)	101.6 (4.00)	80.7 (3.18)

HET*2 manifolds are available in 316/316L Stainless Steel material only.

3-Valve Manifolds - H Series

Direct mount

These 3-valve direct mount to differential pressure transmitter manifolds combine three needle valves into one unitised block to create Isolation for the instrument impulse lines and an Equalisation feature to assist in installation and maintenance. They comply fully with IEC 61518 and have a multitude of advantageous connection & application options.

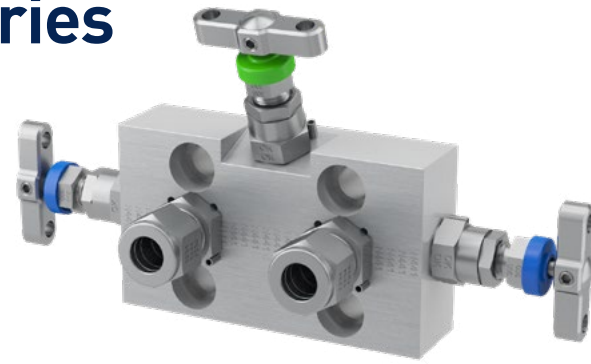

Example shown: 3-valve manifold with PTFree connect™ connection.

HD*3M - Female threaded - NPT x Flanged

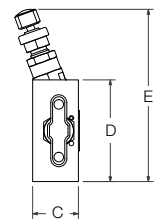
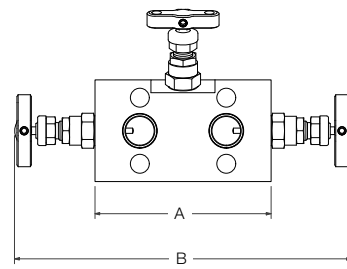
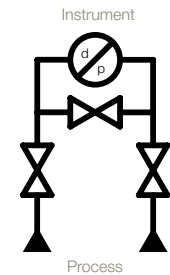

Inlet	Outlet	Dimension				
		A mm (inch)	B mm (inch)	C mm (inch)	D mm (inch)	E mm (inch)
1/2" NPT	Flanged	110.0 (4.33)	211.6 (8.33)	28.6 (1.13)	63.5 (2.50)	107.6 (4.24)

HD*3MA - Female threaded - NPT x Flanged

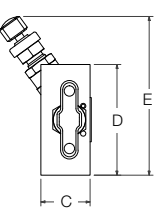
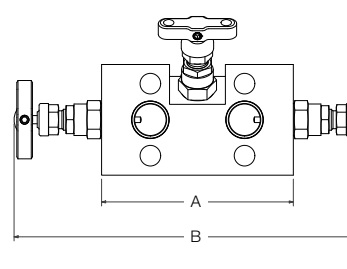
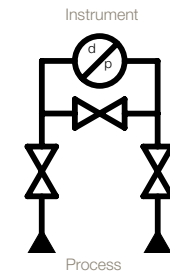

Inlet	Outlet	Dimension				
		A mm (inch)	B mm (inch)	C mm (inch)	D mm (inch)	E mm (inch)
1/2" NPT	Flanged	110.0 (4.33)	211.6 (8.33)	28.6 (1.13)	63.5 (2.50)	91.0 (3.58)

HD*3MDTP - Female threaded - NPT x Flanged with downstream test ports

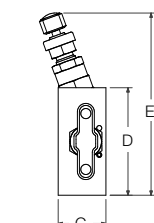
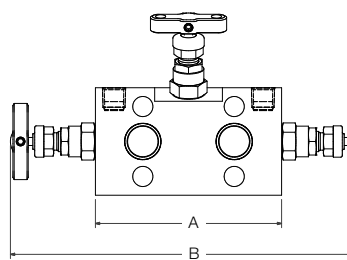
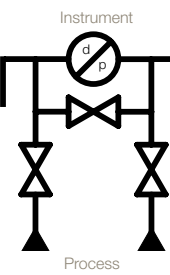
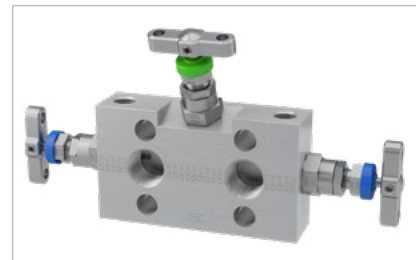

Inlet	Outlet	Dimension					
		A mm (inch)	B mm (inch)	C mm (inch)	D mm (inch)	E mm (inch)	F mm (inch)
1/2" NPT	Flanged	33.0 (1.30)	110.0 (4.33)	211.6 (8.33)	28.6 (1.13)	63.5 (2.50)	107.6 (4.24)

HET*3 - Female threaded - NPT x Flanged

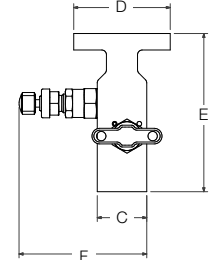
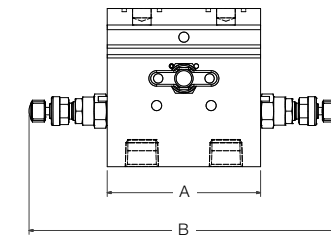
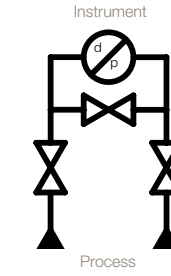

Inlet	Outlet	Dimension					
		A mm (inch)	B mm (inch)	C mm (inch)	D mm (inch)	E mm (inch)	F mm (inch)
1/2" NPT	Flanged	98.5 (3.88")	200.1 (7.88")	31.8 (1.25")	62.0 (2.44")	101.6 (4.00")	82.6 (3.25")

HET*3 manifolds are available in 316/316L Stainless Steel material only.

HEH*3 - Flanged x Flanged

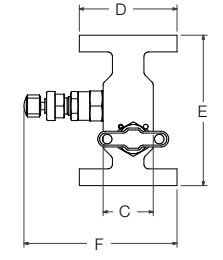
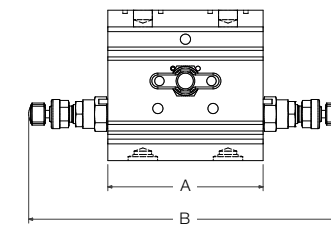
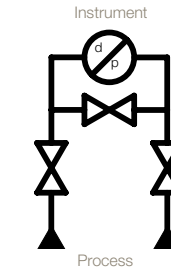

Inlet	Outlet	Dimension					
		A mm (inch)	B mm (inch)	C mm (inch)	D mm (inch)	E mm (inch)	F mm (inch)
Flanged	Flanged	98.5 (3.88")	200.1 (7.88")	31.8 (1.25")	62.0 (2.44")	96.4 (3.80")	97.7 (3.85")

HEH*3 manifolds are available in 316/316L Stainless Steel material only.

Recognising and understanding the direct mount transmitters*



- Manifolds mount to this IEC compliant interface
 - Pressure applications utilise 2-valve manifolds bolted with 2 bolts
 - Differential applications utilise 3 or 5-valve manifolds bolted with 4 bolts
- 7/16" UNF mounting holes
- Connection centres are 2 1/8" (54mm)
- Bolt hole centres are 2 1/8" (54mm) x 1 5/8" (41mm)



Typical installation

* Not Emerson Coplanar™ types – For Coplanar™ please see page 55.

5-Valve Manifolds - H Series

Direct mount

These 5-valve direct mount to differential pressure transmitter manifolds combine five valves into one block, creating isolation for the instrument impulse lines and an Equalisation feature to assist in installation & maintenance. They additionally offer independent vent/drain/bleed/calibration facilities with their own individual ports. These manifolds comply fully with IEC 61518. They also feature multitude of advantageous connection & application options.

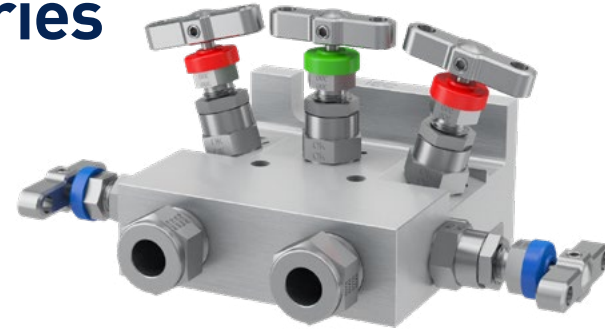

Example shown: 5-valve extruded direct mount manifold with Parker Superior Advantage fully integrated inverted A-LOK® tube fitting connections.

HD*5M - Female threaded - NPT x Flanged

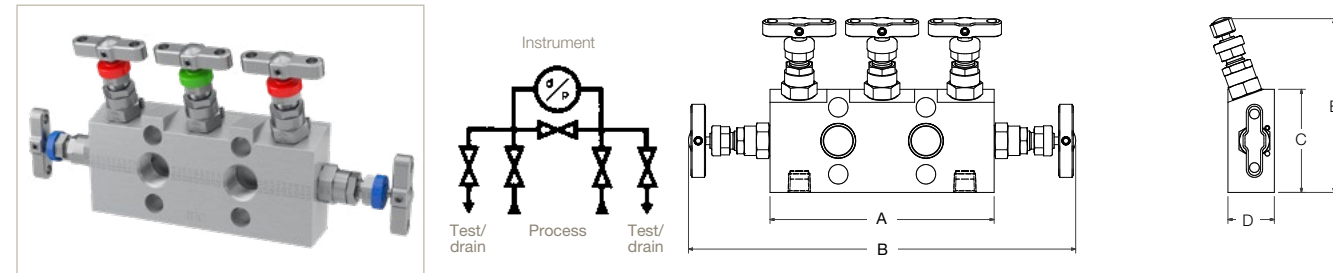

Inlet	Outlet	Bleed/Test	Dimension				
			A mm (inch)	B mm (inch)	C mm (inch)	D mm (inch)	E mm (inch)
1/2" NPT	Flanged	1/4" NPT	138.0 (5.43)	239.6 (9.43)	63.5 (2.50)	28.6 (1.13)	107.6 (4.24)

HD*5MFD variant available with vent/bleed/drain connections on same face as process inlet.

HD*5MA - Female threaded - NPT x Flanged

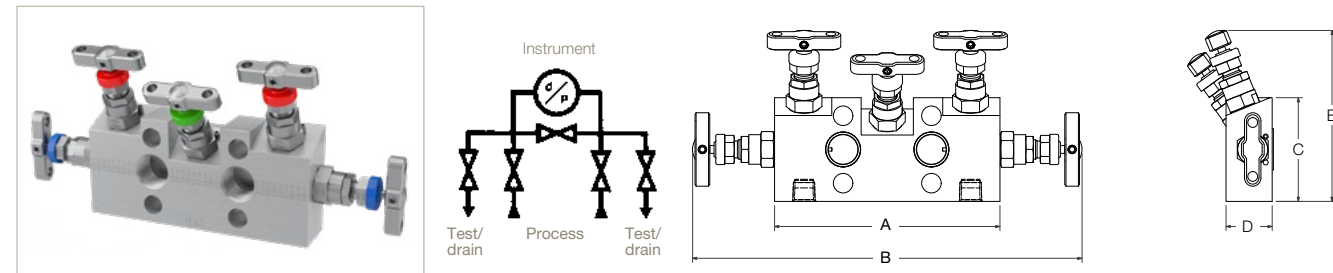

Inlet	Outlet	Bleed/Test	Dimension				
			A mm (inch)	B mm (inch)	C mm (inch)	D mm (inch)	E mm (inch)
1/2" NPT	Flanged	1/4" NPT	138.0 (5.43)	239.6 (9.43)	63.5 (2.50)	28.6 (1.13)	104.7 (4.12)

HD*5MFF - Flanged x Flanged (straight through bolted flange)

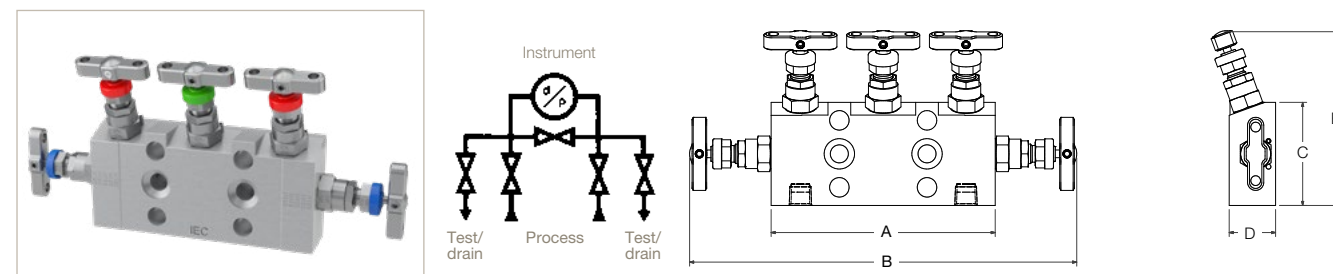

Inlet	Outlet	Bleed/Test	Dimension				
			A mm (inch)	B mm (inch)	C mm (inch)	D mm (inch)	E mm (inch)
Flanged	Flanged	1/4" NPT	138.0 (5.43)	239.6 (9.43)	63.5 (2.50)	28.6 (1.13)	107.6 (4.24)

HD*5 - Female threaded - NPT x Flanged

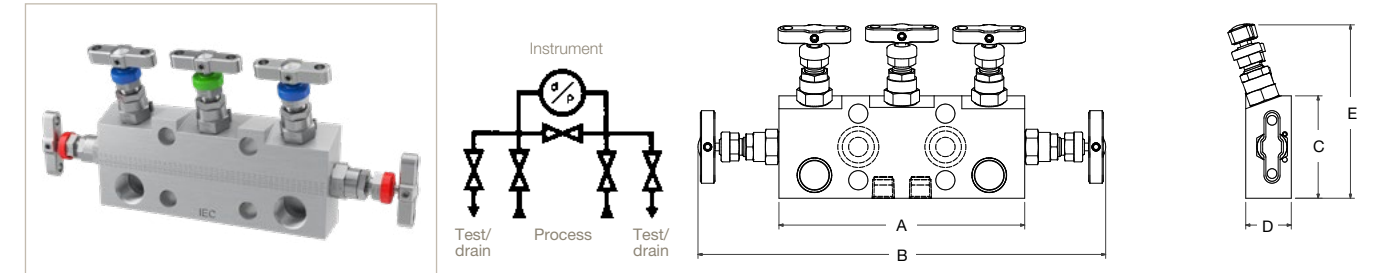

Inlet	Outlet	Bleed/Test	Dimension				
			A mm (inch)	B mm (inch)	C mm (inch)	D mm (inch)	E mm (inch)
1/2" NPT	Flanged	1/4" NPT	152.4 (6.00)	254.0 (10.00)	63.5 (2.50)	28.6 (1.13)	107.6 (4.24)

HD*5CT - Female threaded - NPT x Flanged

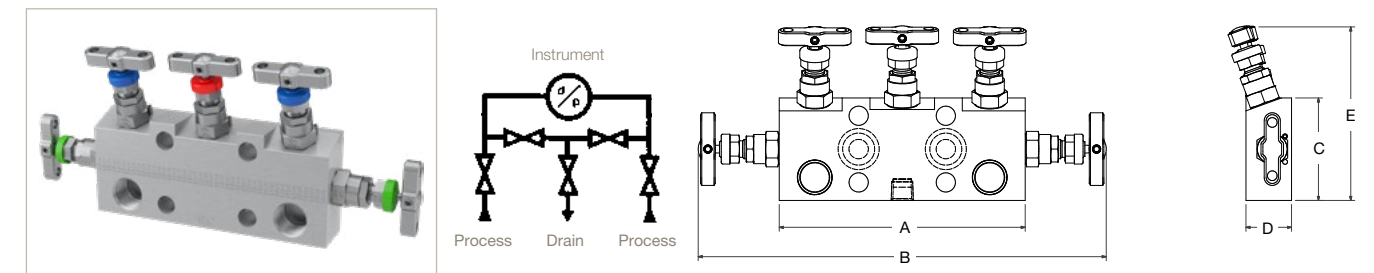

Inlet	Outlet	Bleed/Test	Dimension				
			A mm (inch)	B mm (inch)	C mm (inch)	D mm (inch)	E mm (inch)
1/2" NPT	Flanged	1/4" NPT	152.4 (6.00)	254.0 (10.00)	63.5 (2.50)	28.6 (1.13)	107.6 (4.24)

HEH*5 - Flanged x Flanged

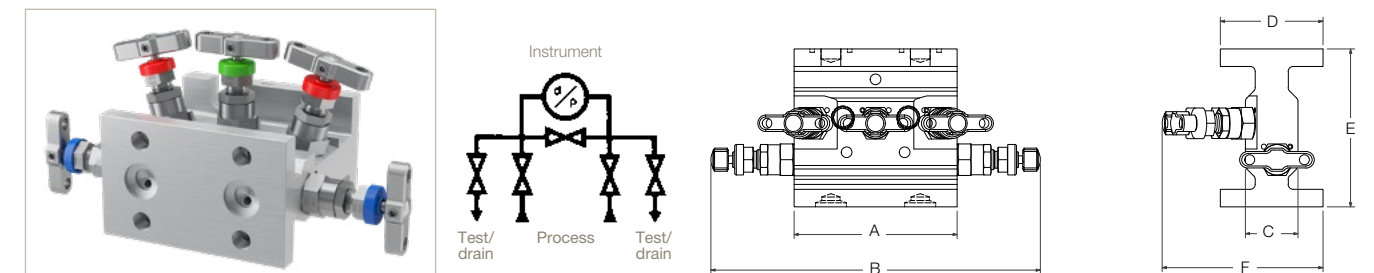

Inlet	Outlet	Bleed/Test	Dimension					
			A mm (inch)	B mm (inch)	C mm (inch)	D mm (inch)	E mm (inch)	F mm (inch)
Flanged	Flanged	1/4" NPT	98.5 (3.88")	200.1 (7.88")	31.8 (1.25")	62.0 (2.44")	96.4 (3.80")	97.7 (3.85")

HEH*5 manifolds are available in 316/316L Stainless Steel material only.

HET*5 - Female threaded - NPT x Flanged

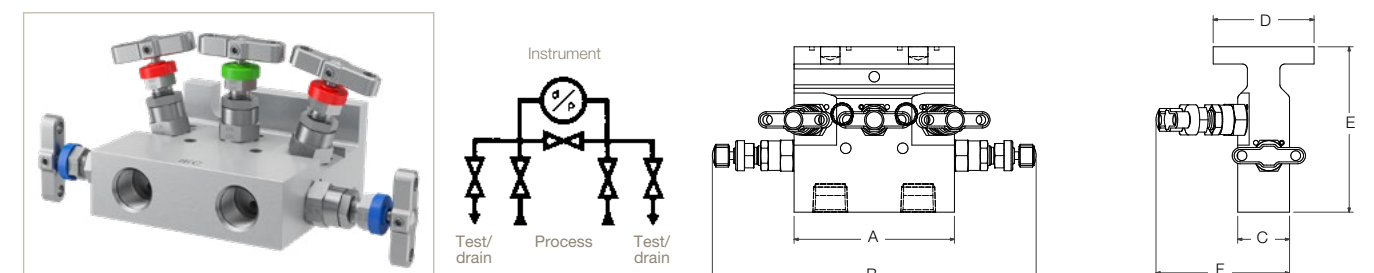

Inlet	Outlet	Bleed/Test	Dimension					
			A mm (inch)	B mm (inch)	C mm (inch)	D mm (inch)	E mm (inch)	F mm (inch)
1/2" NPT	Flanged	1/4" NPT	98.5 (3.88")	200.1 (7.88")	31.8 (1.25")	62.0 (2.44")	101.6 (4.00")	82.6 (3.25")

HET*5 manifolds are available in 316/316L Stainless Steel material only.

2, 3 and 5-Valve Manifolds - Direct Mount

Ordering information

Example 1 (Default): **HDS5M**

Example 2: **HDS5MASB3PBKSNC**

Example 3: **HDM5MADA**

Example 4: **HDS5M4NDAATKVOXNC**

Example 5: **HEHS3DTP3ATE**

Example 6: **HETS5CTP**

Example 7: **HETS5DAIVAM104F3PBKS**

Example 8: **HDM5MADAPFCAM126PKNC**

HD	S	5	M			
HD	S	5	M	A		SB3PBKS
HD	M	5	M	A	DA	
HD	S	5	M		4NDA	ATKVOXNC
HEH	S	3		DTP		3ATE
HET	S	5		CT		P
HET	S	5			DAIVAM104F	3PBKS
HD	M	5	M	A	DAPFCAM126	PKNC

- 5-valve direct mount, flat barstock, thread to DIN IEC B flanged 6,000 PSI manifold, manufactured from 316 SS material having 1/2" NPT Fem. inlet connections and 1/4" NPT Fem. connections to vents. Gland packing is PTFE.
- 5-valve direct mount, flat barstock, thread to DIN IEC B flanged 6,000 PSI manifold, manufactured from 316 SS material having 1/2" NPT Fem. inlet con. and 1/4" NPT Fem. con. to vents. 316 SS bolts. Gland packing is Graphite. Manifold has further inclined equalise valve; fitted with SS mounting bracket assembly; 1/4" NPT blanking plugs supplied.
- 5-valve direct mount, flat barstock, thread to DIN IEC A flanged 5,000 PSI manifold, manufactured from Alloy M400 CRA material having 1/2" NPT Fem. inlet connections and 1/4" NPT Fem. connections to vents. Gland packing is PTFE. Manifold has further inclined equalise valve to avoid obstruction with the transmitter.
- 5-valve direct mount, flat barstock, thread to DIN IEC A flanged 6,000 PSI manifold, manufactured from 316 SS material having 1/4" NPT Fem. inlet con. and 1/4" NPT Fem. vent cons. Gland packing is PTFE. Vent/drain/bleed valve's operation is Anti-Tamper. One Anti-Tamper key is supplied and the manifold is cleaned suitable for use in Oxygen applications, NACE compliant.
- 3-valve direct mount extruded H-section, flange to flange 6,000 PSI manifold, manufactured from 316 SS material having DIN IEC process/inlet interface and IEC B outlet/instrument flange connections. Gland packig is Graphite. Manifold has additional 1/4" NPT downstream test ports and is fitted with Anti-Tamper operation to the equalise valve.
- 5-valve direct mount extruded T-section, pipe/thread to flange 6,000 PSI manifold, manufactured from 316 SS material having 1/2" NPT Fem. inlet and IEC B outlet/instrument flange with 1/4" NPT Fem. bleed/vent/drain. Gland packig is PTFE. Manifold is suitable for use in fiscal metering/custody transfer applications; 1/4" NPT blanking plug is supplied.
- 5-valve direct mount extruded section, tube to DIN IEC A flanged 6,000 PSI manifold, manufactured from 316 SS material having Parker Superior Advantage 10mm Inverted style A-LOK tube connections to the inlet and 1/4" NPT Fem. bleed/vent/drain. Gland packing is Graphite; 1/4" NPT blanking plugs supplied; fitted with SS mounting bracket assembly.
- 5-valve direct mount, flat barstock, tube to DIN IEC A flanged 5,000 PSI manifold, manufactured from Alloy M400 CRA material having Parker Superior Advantage 12mm PTFree A-LOK connections to inlet and 6mm PTFree A-LOK male stud union connections to vent/drain/bleed. Gland packing is PTFE. Manifold has further inclined equalise valve to avoid obstruction with the transmitter; fitted PEEK soft stem tip and conforms to NACE.

Series			
HD¹	Flat barstock direct mount, pipe to flange/thread to flange manifolds - Process connections 108.0 mm (4 1/4") CTRS - Process connections 54.0 mm (2 1/8") CTRS		
HET¹	Extruded T-section direct mount, pipe to flange/thread to flange manifolds		
HEH²	Extruded H-section direct mount, flange to flange manifolds		
Materials			
S	316/316L Stainless Steel	HC	Alloy C276
6MO	6MO Sup. Aust. St.Steel	T	Titanium Gr. 2 ³
M	Alloy M400 ³	825	Alloy 825
D1	Duplex 22 Cr. Steel	625	Alloy 625
D2	Super Duplex 25 Cr. Steel	C	Carbon Steel ⁴

¹ Default standard connections for pipe/thread to flange are: 1/2" NPT Fem. inlet with DIN IEC B outlet transmitter face with 1/4" NPT Fem. vents/drains/bleeds/purge or test ports - where specified. HET manifolds are available in 316/316L Stainless Steel material only.

² Default standard connections for flange to flange are: DIN IEC 61518 inlet to manifold/transmitter interface with DIN IEC B outlet with 1/4" NPT Fem. vents/drains/bleeds/purge or test ports - where specified. HEH manifolds are available in 316/316L Stainless Steel material only.

Number of Valves/Configuration			
2	2-valve, block & bleed/isolate & calibrate/vent/drain		
3	3-valve, isolate & equalise for DP applications		
5	5-valve, isolate, equalise & calibrate/bleed/vent/drain for DP applications		
For Flat Barstock Manifolds only (HD Series)			
M	Process Connections 54.0 mm (2 1/4") CTRS		
Application Configuration			
A	Inclined equalise valve to avoid obstruction with transmitter - Eg. Yokogawa EJA ⁵		
FF	Flange to flange connection ⁵		
FD	Vent/bleed/drain connections on same face as process inlet		
CT	Suitable for fiscal metering/custody transfer applications ⁶		
DTP	Downstream test ports ⁷		

⁵ For flat barstock manifolds only.

⁶ For 5-valve manifolds only.

⁷ For 3-valve manifolds only.

Connections - Standard Options			
	Inlet	Outlet	Vent/Drain/Bleed/ Test/Purge
*	1/2" NPT Fem.	DIN IEC B Flange Interface	1/4" NPT Fem.
**	DIN IEC	DIN IEC B Flange Interface	1/4" NPT Fem.
4N	1/4" NPT Fem.	DIN IEC B Flange Interface	1/4" NPT Fem.
4K	1/4" BSPT	DIN IEC B Flange Interface	1/4" BSPT Fem.
4R	1/4" BSPP Fem.	DIN IEC B Flange Interface	1/4" BSPP Fem.
8K	1/2" BSPT	DIN IEC B Flange Interface	1/4" BSPT Fem.
8R	1/2" BSPP	DIN IEC B Flange Interface	1/4" BSPP Fem.
SW8	1/2" NB Fem. SW ⁸	DIN IEC B Flange Interface	1/4" NPT Fem.
#DA	# Select from above	DIN IEC A Flange Interface	1/4" NPT Fem.

* Default standard connection for pipe/thread to flange manifolds; no designator required.

** Default standard connection for flange to flange manifolds; no designator required.

Default standard manifolds require no additional designators. Example: 1/2" NPT Fem. inlet & DIN IEC B outlet with 1/4" NPT Fem. vent = **HD*5M** (as example above).

As connection choices vary, all connections must be designated. **Examples:**

- 1/2"BSPP Fem. inlet & DIN IEC B outlet with 1/4"NPT Fem. vent = **8R4F**
- 1/2"BSPP Fem. inlet & DIN IEC B outlet with 1/4"BSPT Fem. vent = **8R4K**

⁸ As standard, valves with Female Socket Weld connections will be of the same length as per the equivalent NPT pipe threaded variants.

⁹ **Examples:**

- 10mm A-LOK inverted inlet & 1/4" NPT Fem. vent/drain = **IVAM104F**
- 10mm CPI inverted inlet & 1/4" NPT Fem. vent/drain = **IVZM104F**
- 12mm A-LOK inverted inlet & 6mm vent/drain = **IVAM126**
- 1/2" A-LOK inverted inlet & 1/4" vent/drain = **IVA184**

¹⁰ **Examples:**

- 10mm A-LOK tube stub con. inlet & 1/4" NPT Fem. vent/drain = **PFAM104F**
- 3/8" CPI male union con. inlet & 1/4"NPT Fem. vent/drain = **PFCZ164F**
- 12mm A-LOK male union con. inlet & 6mm A-LOK vent/drain = **PFCAM126**

¹¹ 1/4" NPT Fem. is default standard for bleed/vent/drain, some model types may be available with other connections.

OPTIONS	
Instrument Bolt Options	
SB	316 Stainless Steel bolt ¹¹
CB	3" long Carbon Steel bolt ¹²
CSB	3" long 316 Stainless Steel bolt ¹²
Gland Packing Options	
3	Graphite ¹³
FS	Firesafe design ¹⁴
Seating Options - Needle Valves only	
RT	Regulating/Metering Tip
ST	Stellite Tip
9	PCTFE Soft Tip ¹⁵
PK	PEEK Soft Tip
Plug/Bleed Valve Options ¹⁶	
P	Blank Plug
BV	Bleed Valve/Plug
PBV	Blank Plug and Bleed Valve/Plug
Operator Options ¹⁷	
HW	Handwheel
LHW	Handwheel Locking
THL	T Bar Locking
AT*	Anti-Tamper ¹⁸
ATK*	Anti-Tamper with Key ¹⁹
ATHKEY	Anti-Tamper Key ²⁰
Mounting Options	
BK	Assembled with Carbon Steel bracketry & bolts
BKS	Assembled with Stainless Steel bracketry & bolts
Other Options	
OX	Cleaned & lubricated for Oxygen use
NC	NACE MR-01-75 Compliant
M*	Assembly and Test of Free Issue Instrument

¹¹ Carbon Steel bolt as standard. No designator required.

¹² Extra length bolts to be specified when utilising these manifolds with Emerson Coplanar™ type transmitter with the traditional adaptor flange.

¹³ Not required when Firesafe design option (**FS**) selected.

¹⁴ Not available for PCTFE Soft Tip (**9**) or Oxygen use (**OX**).

¹⁵ 3,000 PSI/207 BAR only. See catalogue page 14.

¹⁶ Plugs supplied loose in a packing box. See page 61.

¹⁷ These options can be specified to independent valves:
Add **E** to specify assembly to Equalise valve only.
Add **I** to specify assembly to Isolate valves.
Add **V** to specify assembly to Vents/Drains/Bleeds.
Examples:
• **HWV** = Handwheel to Vents/Drains/Bleeds.
• **ATE** = Anti-Tamper to Equalise valve.

¹⁸ Anti-Tamper operation and no Key.

¹⁹ Anti-Tamper operation and one Key supplied per manifold.

²⁰ Specify quantity required as separate line item.

* Specify assembly and test option - see page 71.

IMPORTANT NOTES:

- For optimum results in integral tube connections on manifolds, the use of Parker pre-assembly tooling is highly recommended. For inverted style integral tube connections the use of Parker pre-assembly tooling is mandatory.
- Not all options/combinations are available in each single product model type.
- We reserve the right to review/revise this part number structure at any time. If necessary, we can refuse and/or recommend the most suitable alternative part number(s). We may also apply MOQ rules.
- Should your part number selection exceed 25 characters in length when completed, then it is likely to be incorrect, please consult your local Parker representation for assistance.
- If in any doubt, please consult your local Parker representation.

Mounting Brackets

Brackets for direct mount manifolds

Brackets for 2, 3 and 5-valve direct mount manifolds - BKT3

- Universal manifold mounting bracket, suitable for all direct mount manifolds
- This bracket design enables horizontal or vertical instrument positioning.



Image shown: Part No.: HDS2MBK



Image shown: Part No.: HDS3MBK

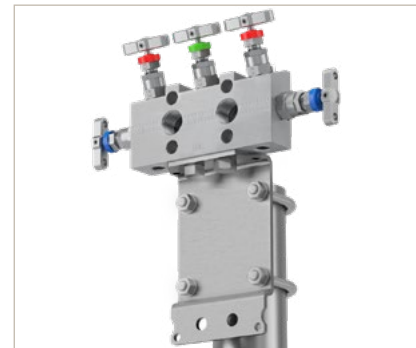
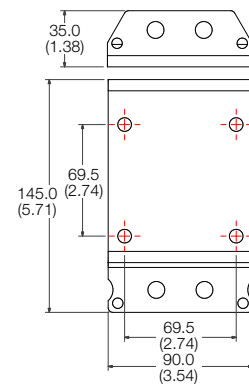

Image shown: Part No.: HDS5MBK



Image shown: Part No.: BKT3CSB2



How to order:

Item	Part Number		Suitable for Manifold Type	
	Bracket material: Carbon Steel	Bracket material: Stainless Steel	2-valve	3 & 5-valve
Bracket with M8 'U' Bolts and manifold Bolt Kit (Nuts and washers: M10 x 12 Bolt (2-OFF))	BKT3CSB2	BKT3SSB2		HD*3M HD*3MDTP HD*3MFF HD*3 HD*5M HD*5MFF
Bracket with M8 'U' Bolts and manifold Bolt Kit (Nuts and washers: M10 x 12 Bolt (1-OFF) M6 x 12 Bolt (1-OFF))	BKT3CSB3	BKT3SSB3	HD*2M HD*2MFF	

'U' bolt with nuts and washers for 2" NB standpipe



Bracket kits include U bolts with nuts and washers.

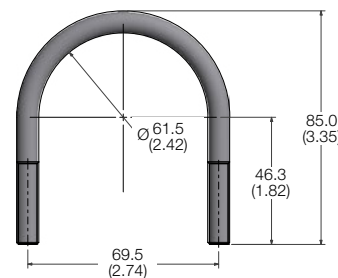

Brackets for 5-valve direct mount HD*5 style manifolds with increased process centres - BKT5

- Universal manifold mounting bracket, suitable for all direct mount manifolds
- This bracket design enables horizontal or vertical instrument positioning



Image shown: Part No.: HDS5BK



Image shown: Part No.: BKT5CSB6

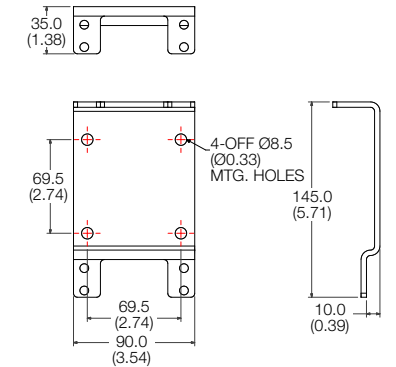

How to order:

Item	Part Number		Suitable for Manifold Type
	Bracket material: Carbon Steel	Bracket material: Stainless Steel	
Bracket with M8 'U' Bolts and manifold Bolt Kit (Nuts and washers: M6 x 12 Bolt (4-OFF))	BKT5CSB6	BKT5SSB6	HD*5CT HD*5

Brackets for 2, 3 and 5-valve direct mount extruded manifolds - BKT4

- Universal manifold mounting bracket, suitable for all direct mount extruded manifolds
- This bracket design enables horizontal or vertical instrument positioning.



Image shown: Part No.: HEHS2BK



Image shown: Part No.: HEHS5BK



Image shown: Part No.: BKT4CSB4

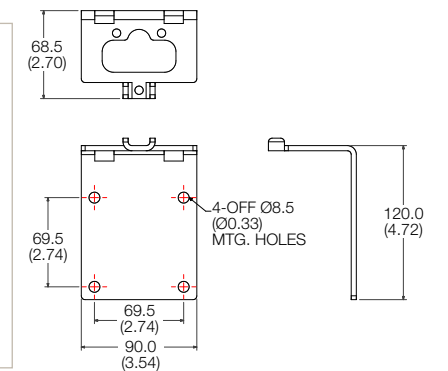

How to order:

Item	Part Number		Suitable for Manifold Type	
	Bracket material: Carbon Steel	Bracket material: Stainless Steel	2-valve	3 & 5-valve
Bracket with M8 'U' Bolt and manifold Bolt Kit (Nuts and washers: M6 x 45 Bolt (3-OFF))	BKT4CSB4	BKT4SSB4	HEH*2 HET*2	HET*3 HEH*3 HET*5 HET*5CT HEH*5 HEH*5CT

Base Connected Manifolds Especially Suited For Enclosure Mounting

Introduction

Suitable for vertical or horizontal installation, these base connection, base mounted manifolds can be utilised in stand-alone applications, but are especially suited for installation with transmitters within an instrument protection enclosure. They offer many benefits, including the ability to complete all connections outside of the enclosure itself. Combined with Parker's own instrument enclosure solutions and specified with the Parker Superior Advantage integral tube fitting connections, these represent the simplest, most efficient and reliable installation solutions available when protection is required.

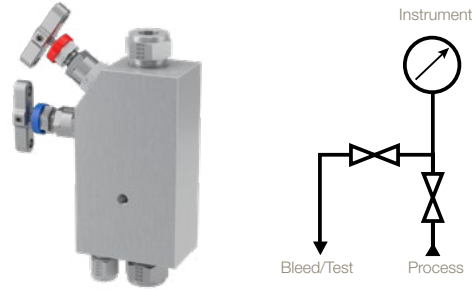

Example shown: 2-valve base connected manifold especially suited for use within enclosures, having Parker Superior Advantage fully integrated inverted style tube connections to inlet, outlet and vent/drain/bleed.

HL*2EXT - Female x Female threaded - NPT

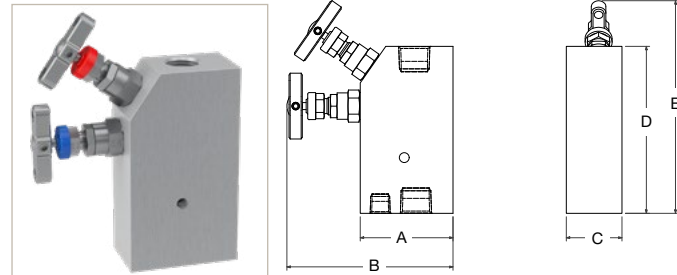

Pressure (PSI)	Inlet	Outlet	Bleed /Test	Dimension				
				A mm (inch)	B mm (inch)	C mm (inch)	D mm (inch)	E mm (inch)
6,000	1/2" F NPT	1/2" F NPT	1/4" F NPT	63.5 (2.50)	114.3 (4.50)	38.1 (1.50)	114.3 (4.50)	145.5 (5.73)

HL*2EXT - Integral A-LOK® connections

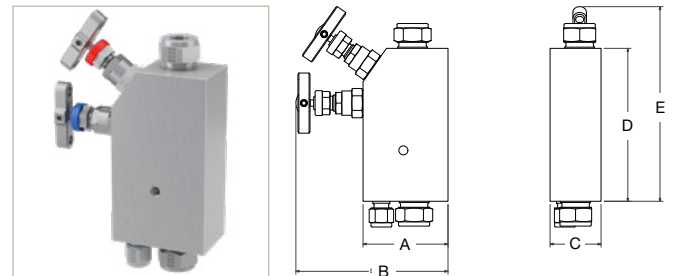

Pressure (PSI)	Inlet	Outlet	Bleed /Test	Dimension				
				A mm (inch)	B mm (inch)	C mm (inch)	D mm (inch)	E mm (inch)
6,000	1/2" A-LOK 12mm	1/2" A-LOK 12mm	1/4" A-LOK 6mm	63.5 (2.50)	114.3 (4.50)	38.1 (1.50)	114.3 (4.50)	145.5 (5.73)

HL*2EXTWG - Female threaded - NPT with integral swivel gauge adaptor

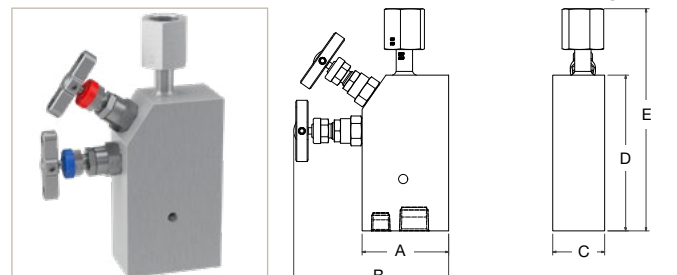

Pressure (PSI)	Inlet	Outlet	Bleed /Test	Dimension				
				A mm (inch)	B mm (inch)	C mm (inch)	D mm (inch)	E mm (inch)
6,000	1/2" F NPT	1/2" F BSPP*	1/4" F NPT	63.5 (2.50)	114.3 (4.50)	38.1 (1.50)	114.3 (4.50)	162.8 (6.40)

*In accordance with DIN 16284 - Swivel BSPP 1/2" Female

- Swivel adaptor to the outlet is provided through a socket weld, generally conforming to ANSI B16.11.
- Weld connection is a "commercial weld", completed by a qualified welder. Any specific qualification, certification, documentation or additional NDT, will require to be engineered and quoted extra - please consult your local Parker support.
- Union nut dimensions generally conform to DIN 16284 as it applies to the union of nipple and nut themselves.
- Union nut also conforms generally to DIN EN 837 for the gauge connection itself, as it applies to the union of nipple and nut themselves.

HD*2EXT - Female threaded - NPT x Flanged

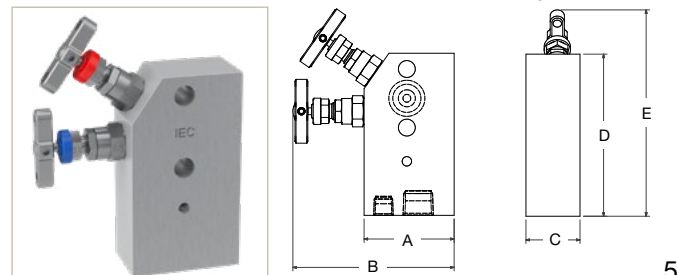

Pressure (PSI)	Inlet	Outlet	Bleed /Test	Dimension				
				A mm (inch)	B mm (inch)	C mm (inch)	D mm (inch)	E mm (inch)
6,000	1/2" F NPT	Flanged	1/4" F NPT	63.5 (2.50)	114.3 (4.50)	38.1 (1.50)	114.3 (4.50)	145.5 (5.73)

HD*3EXT - Female threaded - NPT x Flanged

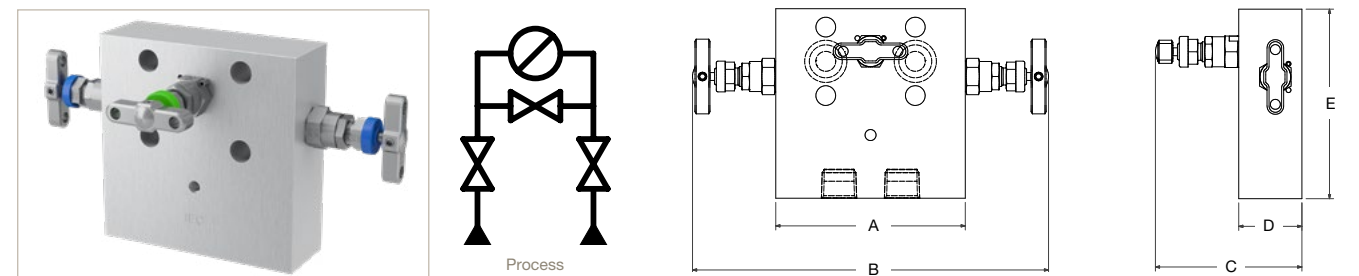

Inlet	Outlet	Drain/Bleed/ Test	Dimension				
			A mm (inch)	B mm (inch)	C mm (inch)	D mm (inch)	E mm (inch)
1/2" NPT	Flanged	Optional	114.3 (4.50)	215.9 (8.50)	88.9 (3.50)	38.1 (1.50)	114.3 (4.50)

HD*5EXT - Female threaded - NPT x Flanged

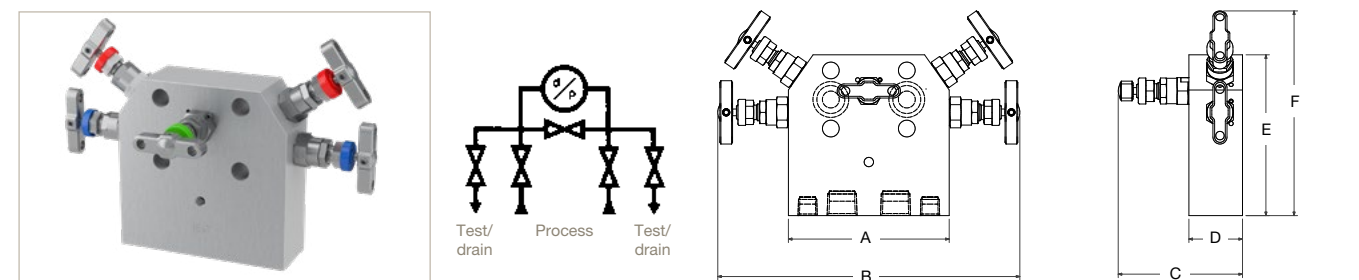

Inlet	Outlet	Drain/Bleed/ Test	Dimension					
			A mm (inch)	B mm (inch)	C mm (inch)	D mm (inch)	E mm (inch)	F mm (inch)
1/2" NPT	Flanged	1/4" NPT	114.3 (4.50)	215.9 (8.50)	88.9 (3.50)	38.1 (1.50)	114.3 (4.50)	145.5 (5.73)

Manifold base footprint dimensions

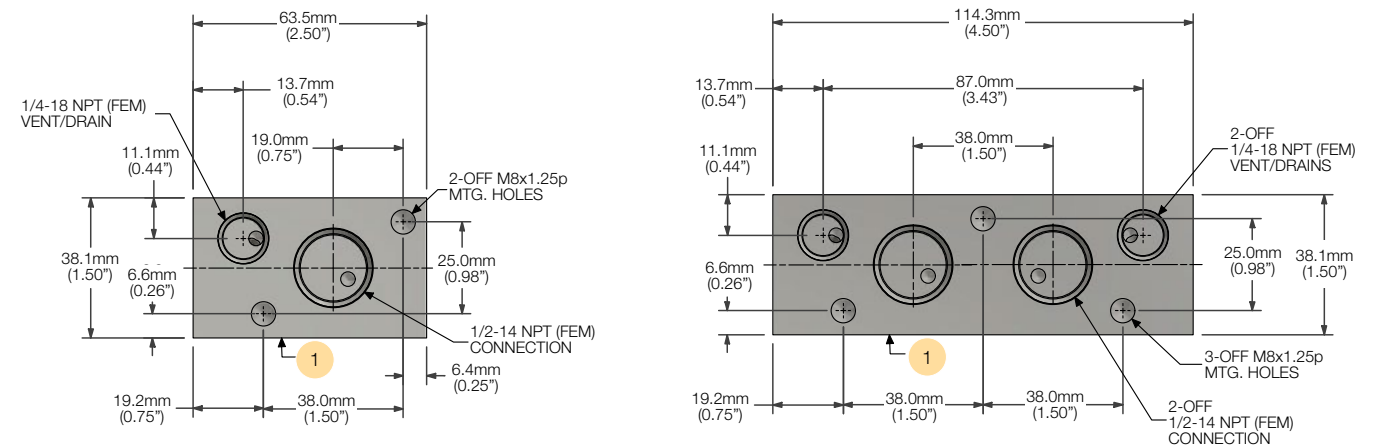

Manifold footprint for 2-valve manifolds. Example shown: HDS2EXT

Manifold footprint for 3 & 5-valve manifolds. Example shown (5-valve): HDS5EXT

Item	Description
1	Manifold outlet to transmitter interface

Notes:

- Recommended base enclosure plate thickness to suit above footprints: 3-5mm.
- Optional variations of these manifold types include compatibility for Emerson Coplanar™ transmitters. Please note, footprint dimensions for the 2-valve equivalents do vary. For further details see page 55.

Base Connected Manifolds Especially Suited For Enclosure Mounting

Ordering information

Example 1 (Default): **HDS5EXT**

Example 2 (Default): **HLS2EXT**

Example 3: **HD6MO3EXTDTP3ATE**

Example 4: **HDM5EXT4NDAATKVOXNC**

Example 5: **HLS2EXTWGP**

Example 6: **HLS2EXTIVZI83BVATE**

Example 7: **HDS5EXTDAPFCAM126PKNC**

HD	S	5	EXT				
HL	S	2	EXT				
HD	6MO	3	EXT	DTP		3ATE	
HD	M	5	EXT		4NDA	ATKVOXNC	
HL	S	2	EXT	WG		P	
HL	S	2	EXT		IVZI84F	3BVATE	
HD	S	5	EXT		DAPFCAM126	PKNC	

- 5-valve barstock base mounted manifold for direct connection to instrument, manufactured from 316 Stainless Steel material having 1/2" NPT Fem. process inlet connections with DIN IEC B outlet flange and 1/4" NPT Fem. vent/drain/bleed. Gland packing is PTFE.
- 2-valve barstock base mounted manifold for remote connection to instrument, manufactured from 316 Stainless Steel material having 1/2" NPT Fem. process inlet and outlet connections with 1/4" NPT Fem. vent/drain/bleed. Gland packing is PTFE.
- 3-valve barstock base mounted manifold for direct connection to instrument, manufactured from 6MO Super Aust. St. St. material having 1/2" NPT Fem. process inlet connections with DIN IEC B outlet flange. Gland packing is Graphite. Additional 1/4" NPT Fem. downstream test con. are provided and there is Anti-tamper operating for the equalise function.
- 5-valve barstock base mounted manifold for direct connection to instrument, manufactured from Alloy M400 CRA material having 1/4" NPT Fem. process inlet connections with DIN IEC A outlet flange and 1/4" NPT Fem. vent/drain/bleed. Gland packing is PTFE. Materials are compliant with NACE, the manifold is cleaned suitable for Oxygen service and the vent valves have Anti-tamper operation with keys.
- 2-valve barstock base mounted manifold for remote connection to instrument, manufactured from 316 St. St. material having 1/2" NPT Fem. process inlet connections with 1/2" BSPP outlet connection to instrument (with integral welded swivel gauge) and 1/4" NPT Fem. vent/drain/bleed. Gland packing is PTFE and a 1/4" NPT blanking plug is provided.
- 2-valve barstock base mounted manifold for remote connection to instrument, manufactured in 316 St. St. material having Parker Superior Advantage fully integrated, inverted style 1/2" CPI tube connections to process inlet and instrument outlet, with 1/4" NPT Fem. vent/drain/bleed. Gland packing is Graphite; there is Anti-tamper operation to the equalise valve and a 1/4" NPT bleed valve plug is supplied.
- 5-valve barstock base mounted manifold for direct connection to instrument, manufactured from 316 St. St. material having Parker Superior Advantage, 12mm PTFree male tube connectors to the process inlet connections, with DIN IEC A outlet flange and 6mm PTFree male tube connectors to vent/drain/bleed. Gland packing is PTFE, the valves have a PEEK soft tip and materials are compliant to NACE.

Series	
HL	Pipe to pipe/Thread to thread connections ¹
HD	Pipe/Thread to IEC flange connection ²

¹ 2-valve manifolds only.
² Default standard connections for pipe/thread to flange are: 1/2" NPT Fem. inlet with DIN IEC B outlet transmitter face with 1/4" NPT Fem. vents/drains/bleeds/purge or test ports - where specified.

Materials			
S	316/316L Stainless Steel	HC	Alloy C276
6MO	6MO Sup. Aust. St.Steel	T	Titanium Gr. 2 ³
M	Alloy M400 ³	825	Alloy 825
D1	Duplex 22 Cr. Steel	625	Alloy 625
D2	Super Duplex 25 Cr. Steel	C	Carbon Steel ⁴

³ This material selection down-rates manifold.
⁴ For Carbon Steel consult your local Parker representation.

Number of Valves/Configuration	
2	2-valve, block & bleed/isolate & calibrate/vent/drain
3	3-valve, isolate & equalise for DP applications
5	5-valve, isolate, equalise & calibrate/bleed/vent/drain for DP applications

EXT	Mandatory designator for Base Mounted Manifolds
------------	-------------------------------------------------

Application Configuration	
WG	Integral swivel gauge connection - 1/2" BSPP (HL*EXT versions only) ⁵
CT	Suitable for fiscal metering/custody transfer applications (5-valve versions only)
DTP	Downstream test ports - 1/4" NPT only (3-valve versions only)

- Swivel adaptor to the outlet is provided through a socket weld, generally conforming to ANSI B16.11.
- Weld connection is a "commercial weld", completed by a qualified welder. Any specific qualification, certification, documentation or additional NDT, will require to be engineered and quoted extra - please consult your local Parker support.
- Union nut dimensions generally conform to DIN 16284 as it applies to the union of nipple and nut themselves.
- Union nut also conforms generally to DIN EN 837 for the gauge connection itself, as it applies to the union of nipple and nut themselves.

Connections - Standard Options				
	Inlet	Outlet		Vent/Drain/Bleed/Test/Purge
		HL Remote Style	HD Direct Style	
*	1/2" NPT Fem.	1/2" NPT Fem.	DIN IEC B Flange	1/4" NPT Fem.
4N	1/4" NPT Fem.	1/4" NPT Fem.	DIN IEC B Flange	1/4" NPT Fem.
4K	1/4" BSPT Fem.	1/4" BSPT Fem.	DIN IEC B Flange	1/4" BSPT Fem.
4R	1/4" BSPP Fem.	1/4" BSPP Fem.	DIN IEC B Flange	1/4" BSPP Fem.
8K	1/2" BSPT Fem.	1/2" BSPT Fem.	DIN IEC B Flange	1/4" BSPT Fem.
8R	1/2" BSPP Fem.	1/2" BSPP Fem.	DIN IEC B Flange	1/4" BSPP Fem.
SW8	1/2" NB Fem. SW ⁶	1/2" NB Fem. SW ⁶	DIN IEC B Flange	1/4" NPT Fem.
#DA	# Select from above	N/A	DIN IEC A Flange	1/4" NPT Fem.

Optional Connections							
Type	Fitting	Unit	HL Remote Style		HD Direct Style		Vent/Drain/Bleed/Test/Purge
			Inlet/Outlet	Inlet	Outlet		
IV	Inverted Connection Tube OD ⁷	M Metric	6	6mm	6	6mm	4F 1/4" NPT Fem. ⁹
			10	10mm	10	10mm	
PF	PTFree connect tube stub ⁸	Z CPI	12	12mm	12	12mm	DIN IEC Flange
			4	1/4"	4	1/4"	
PFC	PTFree connect male union ⁸	I Imperial	6	3/8"	6	3/8"	4F 1/4" NPT Fem. ⁹
			8	1/2"	8	1/2"	

* Default standard connection; no designator required.
 Examples: **HLS2EXT**, **HDS5EXT**.
 As connection selections vary, further designation is required.

- Examples:
- 1/2"BSPP Fem. inlet, 1/2" BSPT outlet & 1/4" BSPT Fem. vent/drain/bleed = **8R8K4K**
 - 1/2" BSPP Fem. inlet, DIN IEC B outlet & 1/4" NPT Fem. vent/drain/bleed = **8R4F**

⁶ As standard, valves with Female Socket Weld connections will be of the same length as per the equivalent NPT pipe threaded variants.

- ⁷ Examples:
- 10mm A-LOK inverted inlet & 1/4" NPT Fem. vent/drain = **IVAM104F**
 - 10mm CPI inverted inlet & 1/4" NPT Fem. vent/drain = **IVZM104F**
 - 12mm A-LOK inverted inlet & 6mm vent/drain = **IVAM126**

- ⁸ Examples:
- 10mm A-LOK tube stub con. inlet & 1/4" NPT Fem. vent/drain = **PFAM104F**
 - 12mm A-LOK male union con. inlet & 6mm A-LOK vent/drain = **PFCAM126**
- ⁹ 1/4" NPT Fem. is default standard for bleed/vent/drain, some model types may be available with other connections.

OPTIONS	
Instrument Bolt Options	
SB	316 Stainless Steel bolt ¹⁰
CB	3" long Carbon Steel bolt ¹¹
CSB	3" long 316 Stainless Steel bolt ¹¹
Gland Packing Options	
3	Graphite ¹²
FS	Firesafe design ¹³
Seating Options - Needle Valves only	
RT	Regulating/Metering Tip
ST	Stellite Tip
9	PCTFE Soft Tip ¹⁴
PK	PEEK Soft Tip
Plug/Bleed Valve Options ¹⁵	
P	Blank Plug
BV	Bleed Valve/Plug
PBV	Blank Plug and Bleed Valve/Plug
Operator Options ¹⁶	
HW	Handwheel
LHW	Handwheel Locking
THL	T Bar Locking
AT*	Anti-Tamper ¹⁷
ATK*	Anti-Tamper with Key ¹⁸
ATHKEY	Anti-Tamper Key ¹⁹
Other Options	
OX	Cleaned & lubricated for Oxygen use
NC	NACE MR-01-75 Compliant
M*	Assembly and Test of Free Issue Instrument

- ¹⁰ Carbon Steel bolt as standard. No designator required.
 - ¹¹ Extra length bolts to be specified when utilising these manifolds with Emerson Coplanar™ type transmitter with the traditional adaptor flange.
 - ¹² Not required when Firesafe design option (**FS**) selected.
 - ¹³ Not available for PCTFE Soft Tip (**9**) or Oxygen use (**OX**).
 - ¹⁴ 3,000 PSI/207 BAR only. See catalogue page 14.
 - ¹⁵ Plugs supplied loose in a packing box. See page 61.
 - ¹⁶ These options can be specified to independent valves:
 Add **E** to specify assembly to Equalise valve only.
 Add **I** to specify assembly to Isolate valves.
 Add **V** to specify assembly to Vents/Drains/Bleeds.
 Examples:
 • **HWV** = Handwheel to Vents/Drains/Bleeds.
 • **ATE** = Anti-Tamper to Equalise valve.
 - ¹⁷ Anti-Tamper operation and no Key.
 - ¹⁸ Anti-Tamper operation and one Key supplied per manifold.
 - ¹⁹ Specify quantity required as separate line item.
- * Specify assembly and test option - see page 71.

IMPORTANT NOTES:

- For optimum results in integral tube connections on manifolds, the use of Parker pre-assembly tooling is highly recommended. For inverted style integral tube connections the use of Parker pre-assembly tooling is mandatory.
- Not all options/combinations are available in each single product model type.
- We reserve the right to review/revise this part number structure at any time. If necessary, we can refuse and/or recommend the most suitable alternative part number(s). We may also apply MOQ rules.
- Should your part number selection exceed 25 characters in length when completed, then it is likely to be incorrect, please consult your local Parker representation for assistance.
- If in any doubt, please consult your local Parker representation.

Instrument Enclosure Solutions

Introduction

As either stand-alone or as complementary to the EXT style manifolds, Parker instrument enclosure solutions consist of a comprehensive range to suit a wide array of instrumentation applications. The enclosures have a shiny gel-coat external finish that is the same as used in the construction of boats and marine vessels. This enables Parker enclosures to withstand the demands of hostile environments.

Fully assembled systems can be supplied based on your specific project or site requirements. They can be fitted with various pressure or flow measuring instruments and manifolds and a host of other features and accessories.

For full details of this range and accessories see catalogue ref. 4190-ENC.

Item	Description
1	Parker Enclosure
2	Identification Label
3	Thermostat
4	Finned Space Heater
5	Viewing Window
6	Mounting Hub (for 2" NB Pipe Stand)
7	Propstay
8	Junction Box
9	Transmitter
10	Parker Manifold
11	Instrument and Signal Cable Gland

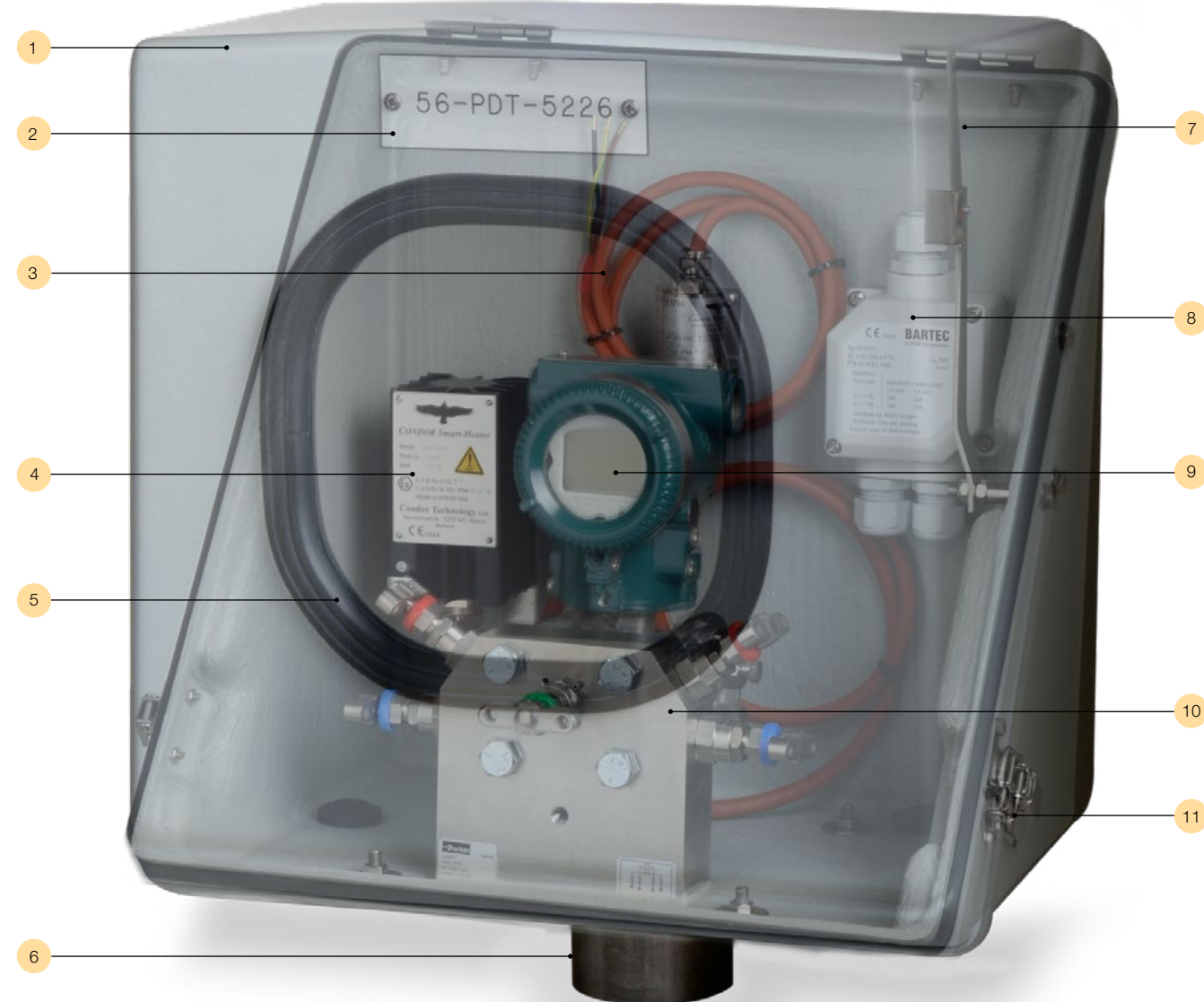

Manifolds for 2051/3051 Coplanar™ Transmitters

Introduction

These are the only direct mount manifolds in the range not to comply with the IEC standard. These Parker 'integral' style manifolds are uniquely designed for connection to the non-traditional Emerson/Rosemount™ Coplanar™ transmitter models and are not suitable for use with the traditional IEC compliant models of this, or other brands.

In this scenario, the assembled manifold/transmitter combination has the advantage of more compact overall dimensions and reduced weight. Typically, these assemblies are wall-mounted or mounted utilising a 2" NB pipestand.

Compatibility of the Parker integral manifold is assured, having been designed and rigorously tested with all the Emerson/Rosemount™ Coplanar™ transmitters, such as 2051 and 3051 models.

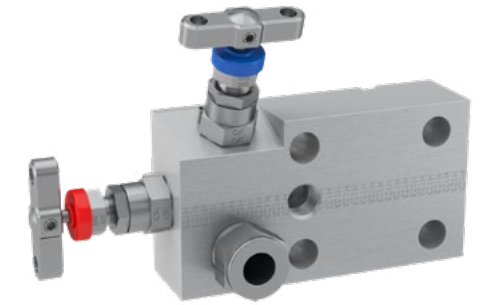

Example shown: 2-valve block and bleed direct mount manifold suitable for Emerson/Rosemount™ Coplanar™ transmitter with Parker Superior Advantage fully integrated inverted A-LOK® tube fitting connections.

Recognising and understanding the Emerson specific Coplanar™ transmitter



3051 DP transmitter, shown with the Emerson flange adapter in lieu of a manifold. A directly mounted Parker Coplanar™ manifold, replaces this.

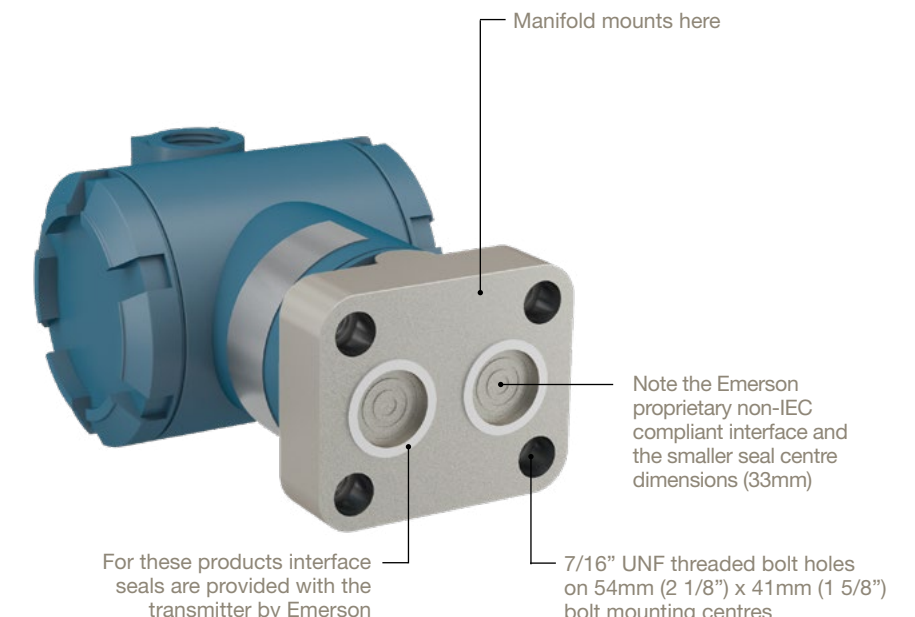

3051 DP transmitter, shown with the Emerson flange adapter removed.

Manifolds for 2051/3051 Coplanar™ Transmitters

HD*2MCP - Female threaded - NPT x Flanged

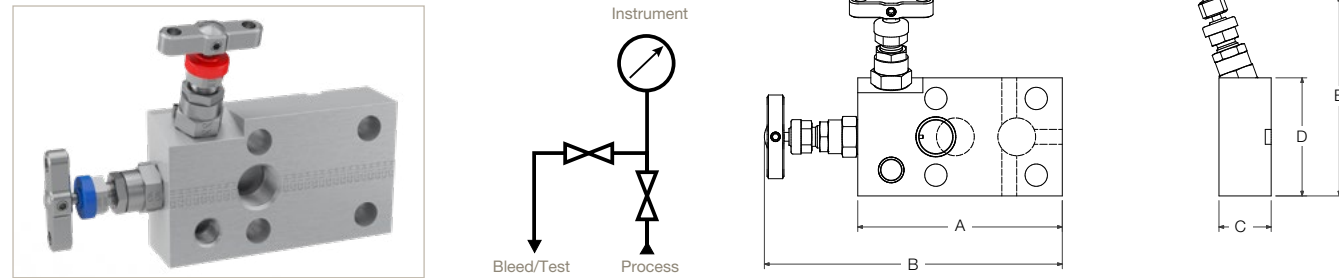

Inlet	Outlet	Bleed/Test	Dimension				
			A mm (inch)	B mm (inch)	C mm (inch)	D mm (inch)	E mm (inch)
1/2" NPT	Flanged	1/4" NPT	110.0 (4.33)	160.8 (6.33)	28.6 (1.13)	63.5 (2.50)	107.6 (4.24)

HD*3MCP - Female threaded - NPT x Flanged

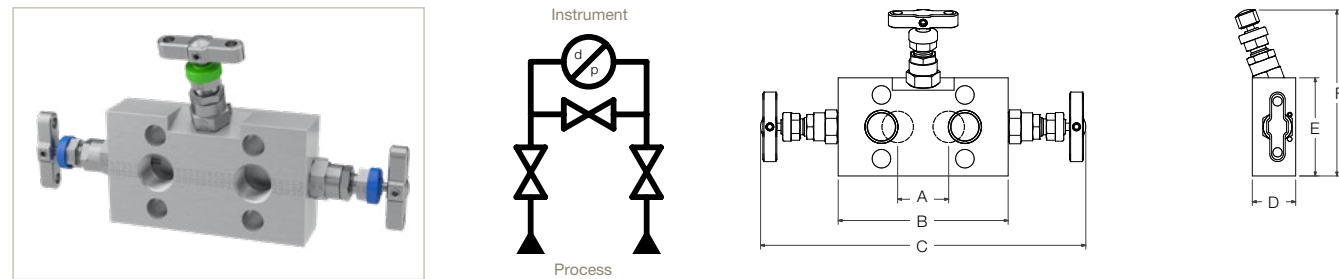

Inlet	Outlet	Bleed/Test	Dimension					
			A mm (inch)	B mm (inch)	C mm (inch)	D mm (inch)	E mm (inch)	F mm (inch)
1/2" NPT	For 3051	Optional	33.0 (1.30)	110.0 (4.33)	211.6 (8.33)	28.6 (1.13)	63.5 (2.50)	107.6 (4.24)

HD*5MCP - Female threaded - NPT x Flanged

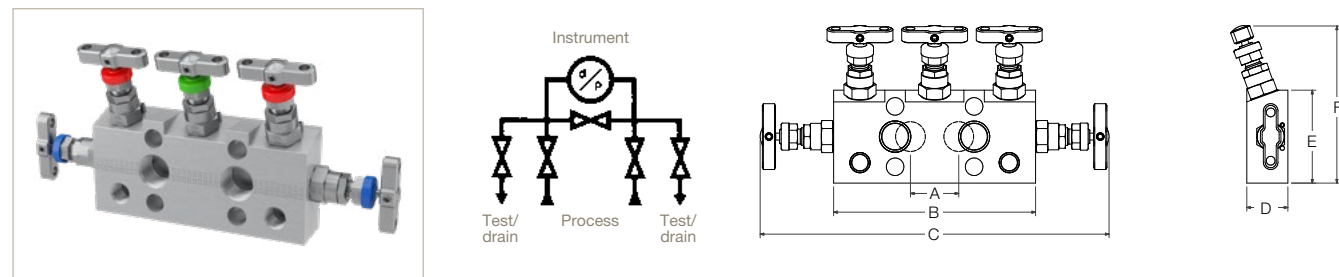

Inlet	Outlet	Bleed/Test	Dimension					
			A mm (inch)	B mm (inch)	C mm (inch)	D mm (inch)	E mm (inch)	F mm (inch)
1/2" NPT	Flanged	1/4" NPT	33.0 (1.30)	138.0 (5.43)	239.6 (9.43)	28.6 (1.13)	63.5 (2.50)	107.6 (4.24)

HD*2MCPEXT - Female threaded - NPT x Flanged

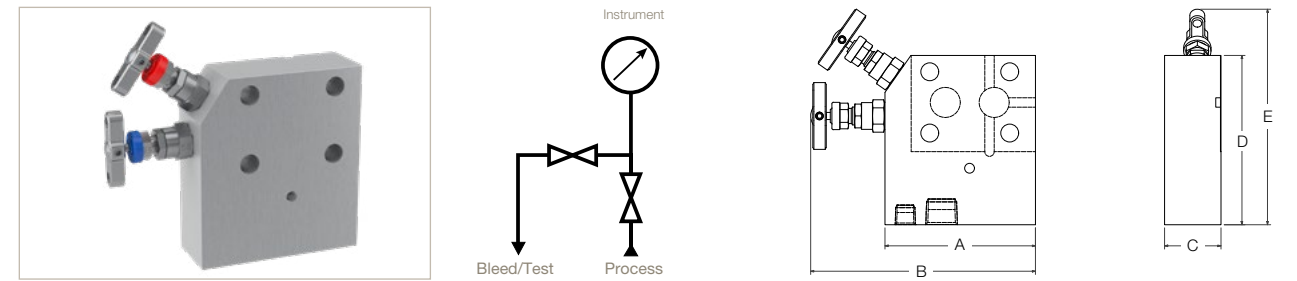

Inlet	Outlet	Bleed/Test	Dimension				
			A mm (inch)	B mm (inch)	C mm (inch)	D mm (inch)	E mm (inch)
1/2" NPT	Flanged	1/4" NPT	101.6 (4.00)	151.8 (5.98)	38.1 (1.50)	114.3 (4.50)	145.5 (5.73)

HD*3MCPEXT - Female threaded - NPT x Flanged

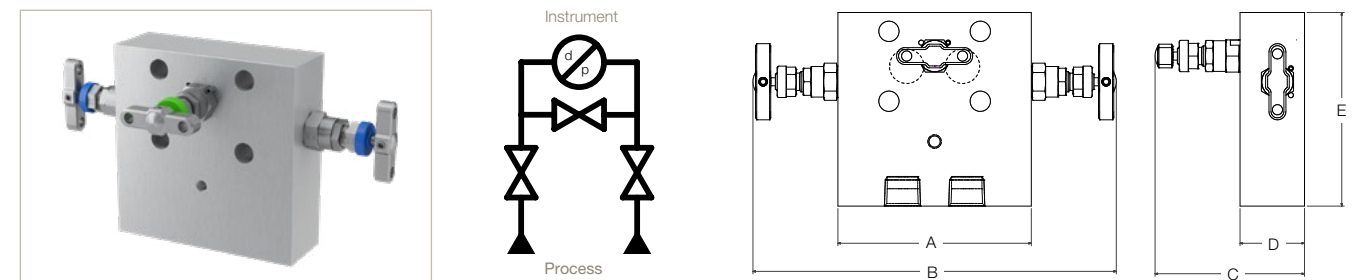

Inlet	Outlet	Drain/Bleed/Test	Dimension				
			A mm (inch)	B mm (inch)	C mm (inch)	D mm (inch)	E mm (inch)
1/2" NPT	Flanged	Optional	114.3 (4.50)	215.9 (8.50)	88.9 (3.50)	38.1 (1.50)	114.3 (4.50)

HD*5MCPEXT - Female threaded - NPT x Flanged

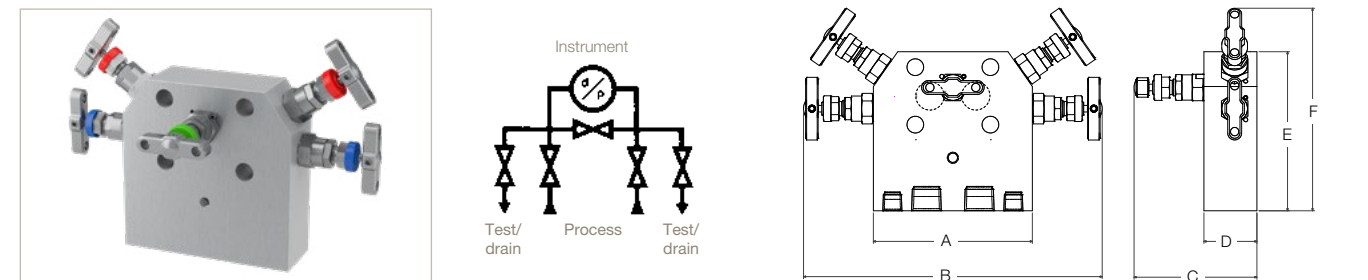

Inlet	Outlet	Drain/Bleed/Test	Dimension					
			A mm (inch)	B mm (inch)	C mm (inch)	D mm (inch)	E mm (inch)	F mm (inch)
1/2" NPT	Flanged	1/4" NPT	114.3 (4.50)	215.9 (8.50)	88.9 (3.50)	38.1 (1.50)	114.3 (4.50)	145.5 (5.73)

Manifolds for 2051/3051 Coplanar™ Transmitters

Ordering information

Example 1 (Default): **HDS5MCP**

Example 2: **HD6MO3MCP EXT DTP 3ATE**

Example 3: **HDM5MCP4NATKVOXNC**

Example 4: **HDS5MCP PFCAM126PKNC**

HD	S	5	MCP			
HD	6MO	3	MCP	EXTDTP		3ATE
HD	M	5	MCP		4N	ATKVOXNC
HD	S	5	MCP		PFCAM126	PKNC

- 5-valve barstock manifold for direct connection to instrument, manufactured from 316 Stainless Steel material having 1/2" NPT Fem. process inlet connections with 2051/3051 Coplanar™ compliant outlet flange and 1/4" NPT Fem. vent/drain/bleed. Gland packing is PTFE.
- 3-valve barstock manifold suitable for base mounting and for direct connection to instrument, manufactured from 6MO Super Austenitic St. St. material having 1/2" NPT Fem. process inlet connections and 2051/3051 Coplanar™ compliant outlet flange. Manifold also has 2 1/4" NPT Fem. downstream test ports. Gland packing is Graphite and the equalise valve has Anti-tamper operation and 1/4" NPT Fem. vent/drain/bleed.
- 5-valve barstock manifold for direct connection to instrument, manufactured from Alloy M400 CRA material having 1/4" NPT Fem. process inlet connections with 2051/3051 Coplanar™ compliant outlet flange and 1/4" NPT Fem. vent/drain/bleed. Gland packing is PTFE, materials comply to NACE; manifold is cleaned suitable for oxygen service and vent valves are Anti-tamper operation with key.
- 5-valve barstock manifold for direct connection to instrument, manufactured from 316 St. St. material having Parker Superior Advantage 12mm A-LOK PTFree male union style process inlet connectons with 2051/3051 Coplanar™ compliant outlet flange. Vent/bleed/drain connections are also PTFree male union style but of 6mm size. Gland packing is PTFE, the valve complies with NACE and all valves have PEEK soft tip seating.

Series	
HD	Flat barstock direct mount to instrument manifolds with 2051/3051 Coplanar™ style outlet flange ¹

¹ Default standard connections for pipe/thread to flange are: 1/2" NPT Fem. inlet with 2051/3051 Coplanar™ outlet flange and 1/4" NPT Fem. vents/drains/bleeds.

Materials			
S	316/316L Stainless Steel	HC	Alloy C276
6MO	6MO Sup. Aust. St. Steel	T	Titanium Gr. 2 ²
M	Alloy M400 ²	825	Alloy 825
D1	Duplex 22 Cr. Steel	625	Alloy 625
D2	Super Duplex 25 Cr. Steel	C	Carbon Steel ³

² This material selection down-rates manifold.

³ For Carbon Steel consult your local Parker representation.

Number of Valves/Configuration	
2	2-valve, block & bleed/isolate & calibrate/vent/drain
3	3-valve, isolate & equalise for DP applications
5	5-valve, isolate, equalise & calibrate/bleed/vent/drain for DP applications

MCP	Mandatory designator defining barstock manifold with traditional inlet centres and 2051/3051 Coplanar™ transmitter interface flange
-----	-------------------------------------------------------------------------------------------------------------------------------------

Application Configuration	
EXT	Extended body base mounting especially suitable for enclosures
CT	Suitable for fiscal meterin/custody transfer applications. 5-valve versions only
DTP	Downstream test ports. 3-valve versions only. 1/4" NPT only

Connections - Standard Options			
	Inlet	Outlet	Vent/Drain/Bleed/Test/Purge
*	1/2" NPT Fem.	2051/3051 Coplanar	1/4" NPT Fem.
4N	1/4" NPT Fem.	2051/3051 Coplanar	1/4" NPT Fem.
4K	1/4" BSPT Fem.	2051/3051 Coplanar	1/4" BSPT Fem.
4R	1/4" BSPP Fem.	2051/3051 Coplanar	1/4" BSPP Fem.
8K	1/2" BSPT Fem.	2051/3051 Coplanar	1/4" BSPT Fem.
8R	1/2" BSPP Fem.	2051/3051 Coplanar	1/4" BSPP Fem.
SW8	1/2" NB Fem. SW ⁴	2051/3051 Coplanar	1/4" NPT Fem.

* Default standard connection; no designator required. Examples: **HDS2MCP**, **HDS5CPEXT**.

As connection selections vary, further designation is required. Example: 1/2" BSPP Fem. inlet, 2051/3051 Coplanar & 1/4" NPT Fem. vent/drain/bleed = **8R4F**

⁴ As standard, valves with Female Socket Weld connections will be of the same length as per the equivalent NPT pipe threaded variants.

Optional Connections					
Type	Fitting	Unit	Inlet	Outlet	Vent/Drain/Bleed/Test/Purge
IV	Inverted Connection Tube OD ⁵	M Metric	6 6mm 10 10mm 12 12mm	2051/3051 Coplanar	4F 1/4" NPT Fem. ⁷
PF	PTFree connect tube stub ⁶	A A-LOK			
PFC	PTFree connect male union ⁶	Z CPI	4 1/4" 6 3/8" 8 1/2"		

⁵ Examples:
 • 10mm A-LOK inverted inlet & 1/4" NPT Fem. vent/drain = **IVAM104F**
 • 10mm CPI inverted inlet & 1/4" NPT Fem. vent/drain = **IVZM104F**
 • 12mm A-LOK inverted inlet & 6mm vent/drain = **IVAM126**

⁶ Examples:
 • 10mm A-LOK tube stub con. inlet & 1/4" NPT Fem. vent/drain = **PFAM104F**
 • 12mm A-LOK male union con. inlet & 6mm A-LOK vent/drain = **PFCAM126**

⁷ 1/4" NPT Fem. is default standard for bleed/vent/drain, some model types may be available with other connections.

OPTIONS	
Instrument Bolt Options	
SB	316 Stainless Steel bolt ⁸
CB	3" long Carbon Steel bolt ⁹
CSB	3" long 316 Stainless Steel bolt ⁹
Gland Packing Options	
3	Graphite ¹⁰
FS	Firesafe design ¹¹
Seating Options - Needle Valves only	
RT	Regulating/Metering Tip
ST	Stellite Tip
9	PCTFE Soft Tip ¹²
PK	PEEK Soft Tip
Plug/Bleed Valve Options ¹³	
P	Blank Plug
BV	Bleed Valve/Plug
PBV	Blank Plug and Bleed Valve/Plug
Operator Options ¹⁴	
HW	Handwheel
LHW	Handwheel Locking
THL	T Bar Locking
AT*	Anti-Tamper ¹⁵
ATK*	Anti-Tamper with Key ¹⁶
ATHKEY	Anti-Tamper Key ¹⁷
Mounting Options ¹⁸	
BK	Assembled with Carbon Steel bracketry & bolts
BKS	Assembled with Stainless Steel bracketry & bolts
Other Options	
OX	Cleaned & lubricated for Oxygen use
NC	NACE MR-01-75 Compliant
M*	Assembly and Test of Free Issue Instrument

⁸ Carbon Steel bolt as standard. No designator required.

⁹ Extra length bolts to be specified when utilising these manifolds with Emerson Coplanar™ type transmitter with the traditional adaptor flange.

¹⁰ Not required when Firesafe design option (**FS**) selected.

¹¹ Not available for PCTFE Soft Tip (**9**) or Oxygen use (**OX**).

¹² 3,000 PSI/207 BAR only. See main catalogue page.

¹³ Plugs supplied loose in a packing box. See page 61.

¹⁴ These options can be specified to independent valves:
 Add **E** to specify assembly to Equalise valve only.
 Add **I** to specify assembly to Isolate valves.
 Add **V** to specify assembly to Vents/Drains/Bleeds.
 Examples:
 • **HWV** = Handwheel to Vents/Drains/Bleeds.
 • **ATE** = Anti-Tamper to Equalise valve.

¹⁵ Anti-Tamper operation and no Key.

¹⁶ Anti-Tamper operation and one Key supplied per manifold.

¹⁷ Specify quantity required as separate line item.

¹⁸ Mounting Options available on **EXT** option.

* Specify assembly and test option - see page 71.

IMPORTANT NOTES:

- For optimum results in integral tube connections on manifolds, the use of Parker pre-assembly tooling is highly recommended. For inverted style integral tube connections the use of Parker pre-assembly tooling is mandatory.
- Not all options/combinations are available in each single product model type.
- We reserve the right to review/revise this part number structure at any time. If necessary, we can refuse and/or recommend the most suitable alternative part number(s). We may also apply MOQ rules.
- Should your part number selection exceed 25 characters in length when completed, then it is likely to be incorrect, please consult your local Parker representation for assistance.
- If in any doubt, please consult your local Parker representation.

Manifolds for 2051/3051 Coplanar™ Transmitters

Brackets for direct mount manifolds

Brackets for 2, 3 and 5-valve direct mount manifolds - BKT3

- Universal manifold mounting bracket, suitable for all direct mount manifolds
- This bracket design enables horizontal or vertical instrument positioning.

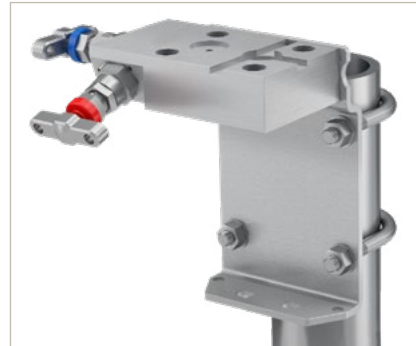

Image shown: Part No.: HDS2MCPBK



Image shown: Part No.: HDS3MCPBK

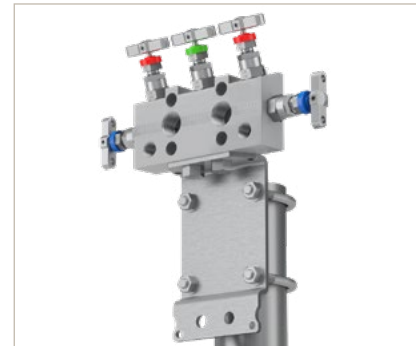
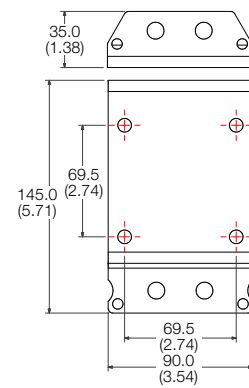

Image shown: Part No.: HDS5MCPBK



Image shown: Part No.: BKT3SSB2



How to order:

Item	Part Number		Suitable for Manifold Type	
	Bracket material: Carbon Steel	Bracket material: Stainless Steel	2-valve	3 & 5-valve
Bracket with M8 'U' Bolts and manifold Bolt Kit (Nuts and washers: M10 x 12 Bolt (2-OFF))	BKT3CSB2	BKT3SSB2	HD*2MCP	HD*3MCP HD*5MCP

Essential Manifold Accessories

Introduction

To complement the entire manifold range and provide complete solutions for all applications, Parker offers the following accessory products. These are in addition to the wide range of brackets and mounting solutions found elsewhere in this catalogue (see pages 34, 40, 48, 49, 60).

Parker can also offer a diverse portfolio of tube fitting solutions and other products, all manufactured to the same exacting standards. Please consult your local Parker representative for further details and information.

Pressure Blanking Plug (Code HPH)

Threaded high quality pressure blanking plug used in manifolds for the blanking off the vent/drain/bleed/test calibration ports, but also available separately for use where any female port requires to be closed off.

Other thread type and sizes may be available.

Ordering information:

Size	Part Number
1/4"	HPH*4M
1/2"	HPH*8M

* Specify material

Materials			
S	316/316L Stainless Steel	HC	Alloy C276
6MO	6MO Sup. Aust. St. Steel	T	Titanium Gr. 2
M	Alloy M400	825	Alloy 825
D1	Duplex 22 Cr. Steel	625	Alloy 625
D2	Super Duplex 25 Cr. Steel		



Pressure Bleed Plug (Code HBV)

Threaded high quality pressure blanking plug, incorporating bleed screw and directional spout; widely used directly in association with the manifolds for the closure of vent/drain/bleed/test calibration ports, but allows the safe & controlled bleed/vent of enclosed process media. These compact bleed plugs are also available separately for use where any female port requires to be closed off and enclosed media is required to be bled off or vented.

The bleed screw itself is captive within the plug, cannot be removed and cannot be ejected in proper use.

Other thread type and sizes may be available.

Ordering information:

Size	Part Number
1/4"	HBV*4M
1/2"	HBV*8M

* Specify material

Materials			
S	316/316L Stainless Steel	HC	Alloy C276
6MO	6MO Sup. Aust. St. Steel	T	Titanium Gr. 2
M	Alloy M400	825	Alloy 825
D1	Duplex 22 Cr. Steel	625	Alloy 625
D2	Super Duplex 25 Cr. Steel		



Compact Gauge Syphon

A discrete range of compact gauge syphons available in 1/2" NPS only - please consult your local Parker support.



Essential Manifold Accessories

Swivel Gauge Adaptors

Parker's range of swivel gauge adaptors has been designed to provide 360° rotational movement enabling maximum positional orientation of installed gauges and measuring instruments. A fully contained sealing mechanism ensures total system integrity and offers the user up to 10,000 psig (690 barg) working pressure. Silver plated swivel nut thread and bearing area prevent thread galling of stainless steel threads and allow trouble free repeatable re-assembly.



Features

- Silver plated swivel thread and bearing surface to prevent thread galling and maximising re-make opportunities
- Variety of thread options
- Compact design
- Fully contained and retained sealing mechanism

Specification

- Available in materials listed below. The nut as standard is 316 Stainless Steel.
- Maximum pressure rating: 10,000 psig (690 barg)
- Maximum temperature rating: 538°C (1000°F)
- Fully heat code traceable

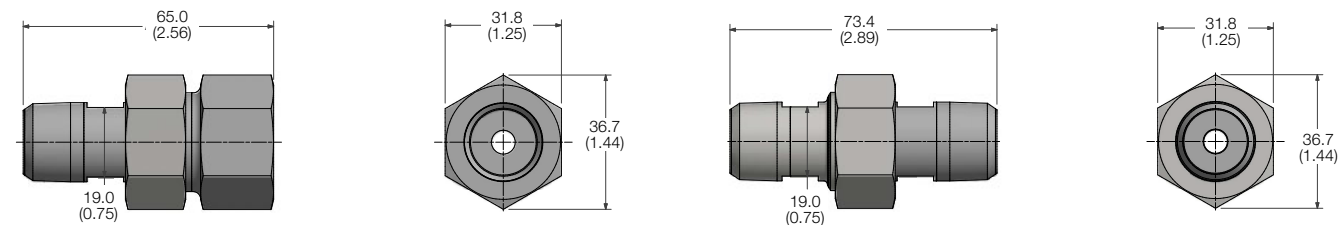

Ordering information:

Example 1: **SGS8M8F3HP**
 Example 2: **SGS8RDM8RFNC**

Series	
SG	Swivel gauge adaptor
Materials	
S	316/316L Stainless Steel
6MO	6MO Sup. Aust. St.Steel
M	Alloy M400
D1	Duplex 22 Cr. Steel
D2	Super Duplex 25 Cr. Steel ¹
Connections - Standard	
Inlet	
4M	1/4" NPT Male
6M	3/8" NPT Male
8M	1/2" NPT Male
Outlet	
4F	1/4" NPT Fem.
6F	3/8" NPT Fem.
8F	1/2" NPT Fem.
4M	1/4" NPT Male
6M	3/8" NPT Male
8M	1/2" NPT Male
Other Connection Options	
*#F	Fem. connection
*#M	Male connection
K	BSPT BS21, ISO7/1 - British Standard Taper Pipe thread
R	BSPP BS2779 - British Standard Parallel Pipe thre
RD	DIN 16284/16288/EN837 BSPP gauge connection type
Options	
3	Graphite Seal option ¹
HP	High Pressure 10,000 PSI option
NC	NACE option

* Insert size designator.
 # Insert specification designator (K/R/RD).

¹ Interface seal material PTFE as standard. Graphite seal optional.

Instrument Flange Adaptors (Kidney/Oval Flanges)



Example shown with traditional 1/2" NPT Fem. connection.



Example shown with integral A-LOK® connection.



Example shown with inverted integral A-LOK® connection.

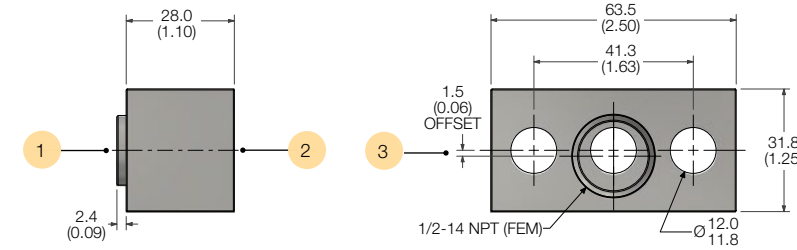

Example of the instrument flange adaptor with 1.5mm offset connection (Code **OS**) which accommodates variation of impulse line centres between 51-57mm.

Ordering information:

Example 1: **HKSM12ASB3**
 Example 2: **HK6MOIM12ASB3**
 Example 3: **HKD18FOSSB**
 Example 4: **HKSBW83**
 Example 5: **HK625BW8AXSB3**

Item	Description
1	IEC A connection to manifold
2	1/2" NPT Fem. connection to process inlet
3	1.5mm (0.06") offset

Series			
HK	Kidney/oval flange		
Materials			
S	316/316L Stainless Steel		
6MO	6MO Sup. Aust. St.Steel		
M	Alloy M400		
D1	Duplex 22 Cr. Steel ¹		
D2	Super Duplex 25 Cr. Steel ¹		
Connections			
4F	1/4" NPT Fem.		
6F	3/8" NPT Fem.		
8F	1/2" NPT Fem.		
4A	1/4" A-LOK ²		
6A	3/8" A-LOK ²		
8A	1/2" A-LOK ²		
M6A	6mm A-LOK ²		
M10A	10mm A-LOK ²		
M12A	12mm A-LOK ²		
Butt Weld - Pipe			
Type	Size	Schedule (Thickness)	Extension
BW Butt Weld	4 1/4" NB	* Sch.80	* 25mm
	6 3/8" NB	A Sch.160	Y 75mm
	8 1/2" NB	B Sch.XXS	X 100mm
	12 3/4" NB		
Options			
OS	Offset 1.5mm option ³		
SB	Stainless Steel Bolt option ⁴		
3	Graphite Seal option ⁵		
NC	NACE option		

¹ Not available with tube connections.

² For CPI™ change A to Z, example: **M10Z**.

* No designator required.

³ Offset option only available on Fem. threaded connection; accommodates variation of impulse line centres between 51-57mm. See diagram above.

⁴ Bolt material as standard HT Carbon Steel. Stainless Steel optional. Both in accordance with IEC 61518.

⁵ Interface seal material PTFE as standard. Graphite seal optional. Both in accordance with DIN IEC 61518 Type A.

OTHER NOTES:

- Tube connection selection as per Parker recommended tube guides.
- Flange interface connection to DIN IEC 61518 Type A.
- Inverted A-LOK® connections supplied with Socket Cap Head bolts. All other connections supplied with Hex Head bolts.
- Not all options/combinations are necessarily available in each single product model type. Care should be taken to consult the main catalogue. If in doubt, please consult your local Parker representation.

Other Manifold Products

Introduction

Proportional Relief Valves - HPRV Series

This range of exceptional Pressure Relief Valves (HPRV) provides an automatic protection mechanism for process instrumentation systems. CE-marked and certified to the highest Category-IV level of the Pressure Equipment Directive (PED), the HPRV valve's design provides users with accurate and consistent cracking and resealing operation.

For full details see Catalogue ref. 4190-HPRV.



Check Valves - Hi-Check Series

These rugged high performance non-return valves offer the user a cold working pressure rating up to 10,000 psi. The true metal-sealed two-piece design ensures potential leakage points are kept to a minimum.

As with our manifold range, we can offer the Parker Superior Advantage of integral tube connections. This further avoids system contamination, reduces potential leakage, weight, space and installation cost.

For full details see Catalogue ref. 4190-CV.



Needle Valves 20,000 PSI

This highest performing H-Series needle valve has been purpose designed for operation with any fluid up to 20,000 psi (1379 bar) rating. Complete with standard PTFE gland packing and non-rotational tip, it gives the user assurance of total in-service sealing security.

100% repeatable bubble tight shut off and Tru-Loc® gland adjuster security are key features of this design. A range of end connections is offered and includes the innovative Phastite® ferrule-less tube fitting or the market-leading Parker Autoclave Medium Pressure Cone & Thread – the ultimate Parker Superior Advantage combination. Additional options include NACE compatibility and heat code traceable materials.

For full details see Catalogue ref. 4190-HH/20K.



Large Bore Needle Valves

Another rugged high performer, this safe, reliable product was developed to operate across a wide pressure and temperature range, in dirty or hydrate service conditions. This Large Bore Needle / Globe Isolation Valves provide reliable bubble tight isolation, with significantly reduced risk of blocking compared to conventional needle valves. This full 1/2" (12.7mm) bore metal seated globe style needle isolation hand valve is available in 316L Stainless Steel or Duplex materials. It complies with ASME VIII ASME/ANSI B16.34 piping class specifications and is ruggedly constructed with a bolted body & bonnet interface.

For full details see Catalogue ref. 4190-HH/LBV.



Distribution Manifolds - HCDM Series

Based exclusively around the H series needle valve design, this compact distribution manifold offers operating pressures up to 6,000 psi for a wide selection of process media. It is available as standard in 316L Stainless Steel material with five or ten outlets, and is ideal for use where high performance is required and space is limited. Bore size through the valves is 4mm as standard; operation is with anti-tamper key, which further enhances the compact design.

For full details see Catalogue ref. 4190-DM.



Distribution Manifolds - HDM

Based entirely around the H-series complete bonnet assemblies, this distribution manifold offers operating pressures up to 6,000 psi for a wide selection of process media. It is available as standard in 316L Stainless Steel material and offers a choice of outlets from 4 to 20. Bore size through the valves is 4mm.

For further details consult your local Parker support.



Condensate Pots

Primary used to increase the accuracy of flow measurement in steam pipelines, these condensate pots provide an interface between the vapour phase and the condensed phase in the impulse lines. These condensate pots are available in a range of materials and have been designed in accordance with ASME VIII Div 1, and are produced in an ASME coded workshop. All condensate pots are CE-marked to PED 2014/68/EU for use with Group 2 gases. Typical industry applications include: refineries, power plants, chemical and petrochemical, steel plants and other process industries.

For full details see Bulletin ref. 3010-CP.



Close Coupled Instrument Mounting Systems - CCIMS

These ultimate complete manifold system solutions have been developed to meet constant demand for higher performance in flow measurement. They represent a standardised, yet radical breakthrough for direct coupling of pressure transmitters to pipelines.

CCIMS offers the following benefits:

- Reduced installation
- Reduced ownership cost
- Increased safety
- Lower maintenance
- Dramatically increased process measurement accuracy.

For full details see Catalogue ref. 4190-CCIMS.



Customer Specific Manifold Solutions

Introduction

This catalogue describes the most versatile and comprehensive range of instrumentation manifolds available on the market today. We also understand certain customers and projects can often require custom solution to suit particular needs and we welcome requests in this regard for our consideration. In some circumstances, this can result in an entirely bespoke product range and catalogues. We are pleased to present the following examples.



Shell

As an EFA (Enterprise Frame Agreement) holder to Shell, we offer a complete range of manifolds and accessories, including all components for the Shell modular mounting system, fully conforming to the Shell MES C (Material and Equipment Standards and Code) specifications. For fully detailed information please refer to Catalogue ref. 4190-MESC or contact your local Parker representation.

Total Refining and Chemical

Totally compliant to Total RC's Contract GLOB-0560 and featuring innovative leak-free technologies through the use of Parker Superior Advantage integral tube fitting connections, as well as all welded flanged assemblies, we are proud to offer this unique manifold solutions range and all necessary associated equipment and accessories. These product solutions save significant engineering and installation costs for this demanding user of process instrumentation systems. For fully detailed information please refer to Catalogue ref. 4190-Total or contact your local Parker representation.



MESC Manifolds IEC 61518

1 Valve Manifold - Type A - double isolator/remote bleed for general applications

- IEC 61518-2001
- Dual isolate, isolate and vent valves
- GSC/ GPPT remote part supplied with either 1/2" or 3/8" OD or 1/4" or 3/16" ID x 1.5" L x 1.5" W
- Compression fittings fitted and packed
- PTFE seal kit included
- Gaskets sub-packaging on standard

Size	Material	Part Number	DPPT Part Number
A	Aluminum	44900AL01	44900AL01DPPT
B	Aluminum	44900AL02	44900AL02DPPT
C	Aluminum	44900AL03	44900AL03DPPT

2 Valve Manifold - Type B - double isolator/remote bleed for applications where concentration of process streams and venting are permitted

- IEC 61518-2001
- Dual isolate, isolate and vent valves
- GSC/ GPPT remote part supplied with either 1/2" or 3/8" OD or 1/4" or 3/16" ID x 1.5" L x 1.5" W
- Compression fittings fitted and packed
- PTFE seal kit included
- Gaskets sub-packaging on standard

Size	Material	Part Number	DPPT Part Number
A	Aluminum	44900AL04	44900AL04DPPT
B	Aluminum	44900AL05	44900AL05DPPT
C	Aluminum	44900AL06	44900AL06DPPT

Enclosures and Protective Shades Introduction

Parker is able to supply a range of robust Enclosure and Protective (EPP) Enclosures and Protective Shades to protect field mounted instrumentation from harsh environments.

An enclosure or shade covering the most common and general purpose sensors and provides protection from severe weather, other adverse conditions and prevents damage to the instrumentation by airborne dirt particles entering the enclosure or the sensor.

Why?

- Available with wide range of Parker manifolds
- Fully isolate single, double and triple connections
- Fully isolate GSC/ GPPT connections
- Available with standard and customised options
- Customisable with standard and optional features
- Available for all engineering environments

Why Protect?

- Prevent instrumentation from weather and other adverse conditions
- Prevent instrumentation from dust, dirt and debris
- Prevent instrumentation from vibration
- Prevent instrumentation from electromagnetic interference
- Prevent instrumentation from tampering
- Prevent instrumentation from unauthorized access

Need any help?

If you need to discuss the benefits of an enclosure or shade for your instrumentation systems, please contact your local Parker representative or visit our website at www.parker.com. We would be happy to help you configuring a manifold solution, Parker includes your contact details on the back page of this brochure for local sales offices.

Enclosures and Protective Shades MESC Manifold Enclosure System

Field instrumentation can be housed in a robust enclosure or shade. The enclosure or shade can be fitted to a manifold with remote bleed or non-remote bleed connections. It can be fitted with various pressure or flow transmitters and can manage the harsh environmental and process conditions. Please contact us with your requirements.

The system is also ready for customisation and can be fitted with a customised remote bleed connection for your specific process or site requirements.

Why Protect?

- Prevent instrumentation from weather and other adverse conditions
- Prevent instrumentation from dust, dirt and debris
- Prevent instrumentation from vibration
- Prevent instrumentation from electromagnetic interference
- Prevent instrumentation from tampering
- Prevent instrumentation from unauthorized access

Need any help?

If you need to discuss the benefits of an enclosure or shade for your instrumentation systems, please contact your local Parker representative or visit our website at www.parker.com. We would be happy to help you configuring a manifold solution, Parker includes your contact details on the back page of this brochure for local sales offices.

Manifold Accessories Seal Pits, Purge and Heating Blocks

Seal pits, purges and heating blocks are available to provide protection or to maintain the process temperature of the media being transferred. The blocks are made from stainless steel, providing a highly efficient conductor of heat transfer to the manifold and transmitter body.

Seal Pits

Seal pits are designed for instrumentation systems requiring an open seal each side, typically of high temperature service. An internal seal ring is used with the seal and a gasket is fitted in front of the manifold and instrument seal to ensure a tight seal to derive the process media.

Seal Pit Working Pressure:

- 411 bar (5900 psi) @ 80°C (176°F)
- Maximum working temperature: 450°C (842°F)

Material	Seal Pit	Part Number	DPPT Part Number
Aluminum	Seal Pit	44900AL07	44900AL07DPPT
Aluminum	Seal Pit	44900AL08	44900AL08DPPT
Aluminum	Seal Pit	44900AL09	44900AL09DPPT

Seal Pit Working Pressure:

- 411 bar (5900 psi) @ 80°C (176°F)
- Maximum working temperature: 450°C (842°F)

Manifold Accessories Filling Connector and Port Protector

Filling connector is available for when purge protection is required for a range of manifolds. The single manifold line through the instrument carries allowing the system to be filled. It comes with an integral check valve.

Port Protector

Parker's port protectors (Lead double bleed) protect open ends of instrumentation, filling and vent lines. The closed wire screen prevents foreign bodies such as insects or debris from entering and clogging instrumentation and causing damage.

Seal Pits

Seal pits are designed for instrumentation systems requiring an open seal each side, typically of high temperature service. An internal seal ring is used with the seal and a gasket is fitted in front of the manifold and instrument seal to ensure a tight seal to derive the process media.

Seal Pit Working Pressure:

- 411 bar (5900 psi) @ 80°C (176°F)
- Maximum working temperature: 450°C (842°F)

Material	Seal Pit	Part Number	DPPT Part Number
Aluminum	Seal Pit	44900AL07	44900AL07DPPT
Aluminum	Seal Pit	44900AL08	44900AL08DPPT
Aluminum	Seal Pit	44900AL09	44900AL09DPPT

Manifold Accessories Filling Connector and Port Protector

Filling connector is available for when purge protection is required for a range of manifolds. The single manifold line through the instrument carries allowing the system to be filled. It comes with an integral check valve.

Port Protector

Parker's port protectors (Lead double bleed) protect open ends of instrumentation, filling and vent lines. The closed wire screen prevents foreign bodies such as insects or debris from entering and clogging instrumentation and causing damage.

Seal Pits

Seal pits are designed for instrumentation systems requiring an open seal each side, typically of high temperature service. An internal seal ring is used with the seal and a gasket is fitted in front of the manifold and instrument seal to ensure a tight seal to derive the process media.

Seal Pit Working Pressure:

- 411 bar (5900 psi) @ 80°C (176°F)
- Maximum working temperature: 450°C (842°F)

Material	Seal Pit	Part Number	DPPT Part Number
Aluminum	Seal Pit	44900AL07	44900AL07DPPT
Aluminum	Seal Pit	44900AL08	44900AL08DPPT
Aluminum	Seal Pit	44900AL09	44900AL09DPPT

Manifolds Class 600 and 1500

Total RC THR RC INS 920 Contract: GLOB-0560

ENGINEERING YOUR SUCCESS.

Manifolds for Transmitters

2, 4, 5 Valve Manifolds for Transmitter to Piping Class 600

- 2 Valve Manifold
- With Seal Training
- Flange DN15 (1/2" NPT)
- IEC 4118 Type B

Size	Material	Seals	Total Part Number	Parker Part Number
1/2" (DN15)	Aluminum	PTFE	44900AL10	44900AL10DPPT
1/2" (DN15)	Aluminum	PTFE	44900AL11	44900AL11DPPT
1/2" (DN15)	Aluminum	PTFE	44900AL12	44900AL12DPPT

Manifolds for Pressure Gauges

2 Valve Manifold for Pressure Gauge Flange to Tubing

- 2 Valve Manifold
- With Seal Training
- Flange DN15 (1/2" NPT)
- IEC 4118 Type B

Size	Material	Seals	Total Part Number	Parker Part Number
1/2" (DN15)	Aluminum	PTFE	44900AL13	44900AL13DPPT
1/2" (DN15)	Aluminum	PTFE	44900AL14	44900AL14DPPT
1/2" (DN15)	Aluminum	PTFE	44900AL15	44900AL15DPPT

Seals

Dual Mount Seal - Graphite

- IEC 4118
- 2" (50.8 mm) port
- Graphite for standard without extended edges
- PTFE option available

Size	Material	Seals	Total Part Number	Parker Part Number
1/2" (DN15)	Aluminum	PTFE	44900AL16	44900AL16DPPT
1/2" (DN15)	Aluminum	PTFE	44900AL17	44900AL17DPPT
1/2" (DN15)	Aluminum	PTFE	44900AL18	44900AL18DPPT

Complementary Products

Enclosures (Catalogue 4190-ENC)

- Available in a wide range of sizes (single, double or triple seal)
- Available for all instrumentation applications
- Available for all instrumentation applications
- Available for all instrumentation applications
- Available for all instrumentation applications

Protective Shades (Catalogue 4190-ENC)

- Available in a wide range of sizes (single, double or triple seal)
- Available for all instrumentation applications
- Available for all instrumentation applications
- Available for all instrumentation applications
- Available for all instrumentation applications

Complementary Products

Ball Valve B Series (Catalogue 4190-BV)

- 3-way 2-way diverting or spring loaded 3-way selector designs
- Wide temperature applications range
- Rated up to 4000 psi (27.6 MPa)

Seal Pits (Catalogue 4190-SP)

- Available in a wide range of sizes (single, double or triple seal)
- Available for all instrumentation applications
- Available for all instrumentation applications
- Available for all instrumentation applications
- Available for all instrumentation applications

Catalogue ref. 4190-MESC
 Shell MES C Compliant Simline Monoflange, Monoflange (Ball) and Instrument Manifolds EFA: PT3740

Catalogue ref. 4190-Total
 Manifolds Class 600 and 1500. Total RC THR RC INS 920. Contract: GLOB-0560

Complementary Products for Complete Installation Solutions

Modular DBB Valves - Pro-Bloc®

Designed to replace conventional multiple-valve installations currently in use for process measurement interfaces, these single-piece products combine multiple valve types into a single manifold. Potential leak paths are reduced and the mass of the system is lowered, reducing the stresses from loading and vibration. Additionally, these products also improve installation and operational safety factors, together with positive installation cost savings.

For full details see Catalogue ref. 4190-FP.



Monoflange Manifolds

More compact than Pro-Bloc® and adding to further space and weight saving, these monoflanges have primary, secondary and bleed valves assembled on the periphery of the flange. The manifold body can incorporate both O.S.&Y. and instrument needle valves as a mixture or all of the same type. These monoflanges are available from forged or bar stock material and can be certified as being of Firesafe design.

For full details see Catalogue ref. 4190-FP.



Ball Valves and Manifolds Hi-Pro Series

These high performance bi-directional Ball Valves & Manifolds offer the user full cold working pressure ratings up to 10,000 psi (689 bar), giving 100% bubble tight shut off and continuous repeatable performance. These products are suitable for the most demanding applications in the oil, gas and process control industries. All valves also meet the requirements of ANSI B31.1 for use in power plants. The design reduces potential body leakage paths to a minimum. With the added opportunity to select Parker Superior Advantage integral compression ends the user can eliminate the use of taper threads and thread sealant, thus avoiding system contamination, reducing leakage paths, installation costs, weight and space.

For full details see Catalogues ref. 4190-HBV and 4190-HBM.



Air Header Distribution Manifolds - LPAHM Series

These air header distribution manifolds are designed to distribute air from the compressor to the actuators on pneumatic instruments, such as steam flow meters, pressure controllers and valve positioners. They are widely used in industrial chemical processing, plastic processing and energy industries and are approved for low pressure applications up to 275 psi. Manufactured from AISI 316 Stainless Steel material, the air header distribution manifolds offer complete customer system compatibility that reduces installation time and potential leak paths. The coded welded construction with non-destructive tested design minimises the number of potential leak paths, rather than fabricating with instrumentation connections with tubing, therefore reducing labour costs. These manifolds are designed for use with air only and are supplied with a number of lockable ball valves on opposite sides, right side or left side only to prevent unauthorized access.

For full details see Catalogue ref. 4190-DM.



Air Header Distribution Manifolds - HPAHM Series

These distribution manifolds are designed for applications that use liquid or gas, low temperature steam and hydraulic actuation. The pressure rating of these manifolds is dictated by the inlet/outlet Flange Class or the thread connection. These distribution manifolds feature an ergonomic vinyl sleeve on the valve handle to provide positive grip and to ensure ease of operation. Each nut has an innovative domed design, which prevents ingress of moisture and contamination of the thread, therefore preventing corrosion. They feature a part-welded construction, with all welds carried out by coded welders, providing assurance of their robustness and performance. These manifolds are NDT (Non-Destructive Testing) applied, giving the customer greater assurance.

For full details see Catalogue ref. 4190-DM.



Hi-Pro Modular Distribution Manifold

Unique to Parker, these manifolds are the ideal choice when ultimate flexibility is required within a distribution manifold. They are approved to operate at pressures up to 6,000 psi and are used extensively in the oil, gas, chemical and petrochemical industries to provide safety and performance. These innovative Hi-Pro modular distribution manifolds can be easily arranged in a layout to suit a wide range of different applications to distribute liquid or gas. They use standard components, therefore making it more affordable for the customer. The Hi-Pro modular distribution manifolds feature an ergonomic vinyl sleeve on the valve handle to provide positive grip and to ensure ease of operation. Each nut is domed in shape, which prevents ingress of moisture and contamination of the thread, which could cause corrosion. This manifold is available with up to 20 valves (even numbers only - spare valves can be blanked off). Temperature range is up to 232°C with PEEK seats.

For full details see Catalogue ref. 4190-DM.



Lapped Joint Tube Adaptor

Available in the full range of fitting materials and sizes up to 1/2" (M12) as standard, these lapped joint tube adaptors are suitable for applications involving small flanged process valves and offer a simple, safe and effective conversion to instrument lines.



Flange Connector - Flange to Parker Tube Fittings

Offered in a range of materials and with either A-LOK® or CPI™ tube fitting technology, these flange connectors deliver huge flexibility in terms of offering. Tube connections up to 1" (25mm), flange connections up to 2" NB and pressures to ANSI Class 2500 (6,000 PSI Nom.). The one-piece integral connection adaptors allow the safe, easy and efficient transition from process to instrumentation in just one step.



Complementary Products for Complete Installation Solutions

Parker Tube Ended Pressure Gauges

Parker Tube Ended Pressure Gauges monitor vacuum, compound, and positive system pressures up to 1000 psig. Available in lower mount and center back mount configurations, these 360°-positionable gauges are perfect for applications where space is at a premium. Not only do our Tube Ended Gauges do away with additional fittings, they completely eliminate the need for tape and sealants, making installation cleaner and quicker.

For full details see Bulletin ref. 4150-TEG.



Baumer Safety Pressure Gauges

Baumer's safety pressure gauge MEP5 is specially designed for use in corrosive atmospheres and fluids. The gauge has a diameter of 100 mm and can measure pressures from -1...0 to 0...1600 bar at gauge working temperatures of -20...70 °C. The MEP5 has a stainless-steel housing, sensing element, and fully welded process connection. It complies with protection class IP67.

For further details consult your local Parker support.



Added Value Service Solution for Complete Installations

Assembly and Test of Free Issue Instrument

In addition to the added value service of bracket assembly to our manifolds, Parker also offers to fit and/or test your free issue transmitter to the manifold of your choice.

Certification for the assembly will be provided.

Standard test to Parker specifications is a 6 Barg air test for 1 minute.



Ordering information:

Assembly and Test of Free Issue Instrument - Available Options	
M1	BSPP Pressure instrument assembled – Customer to supply seal ring
M2	BSPP Pressure instrument assembled and air tested at 6 Barg to Parker specification for 1 minute – Customer to supply seal ring
M3	NPT Pressure instrument assembled with PTFE tape
M3G	NPT Pressure instrument assembled with Higher Temperature tape
M4	NPT Pressure instrument assembled with Loctite sealant in lieu of tape
M4*	NPT Pressure instrument assembled with requested sealant in lieu of tape
M5	NPT Pressure instrument assembled with PTFE tape and air tested at 6 Barg to Parker specification for 1 minute
M5G	NPT Pressure instrument assembled with Higher Temperature tape and air tested at 6 Barg to Parker specification for 1 minute
M6	NPT Pressure instrument assembled with Loctite sealant in lieu of tape and air tested at 6 Barg to Parker specification for 1 minute
M6*	NPT Pressure instrument assembled with requested sealant in lieu of tape and air tested at 6 Barg to Parker specification for 1 minute
M7	IEC flanged Pressure instrument assembled
M8	IEC flanged Pressure instrument assembled and air tested at 6 Barg to Parker specification for 1 minute
M9	IEC flanged Differential Pressure instrument assembled
M10	IEC flanged Differential Pressure instrument assembled and air tested at 6 Barg to Parker specification for 1 minute
PC	Returned in customer's packing at customer's risk
PP*	Returned in Parker packing

* Quote required. To be determined at quotation stage.

Example: **HDS3MNCM10PC**

⚠ WARNING USER RESPONSIBILITY

FAILURE OR IMPROPER SELECTION OR IMPROPER USE OF THE PRODUCTS DESCRIBED HEREIN OR RELATED ITEMS CAN CAUSE DEATH, PERSONAL INJURY AND PROPERTY DAMAGE.

This document and other information from Parker Hannifin Corporation, its subsidiaries and authorized distributors provide product or system options for further investigation by users having technical expertise.

The user, through its own analysis and testing, is solely responsible for making the final selection of the system and components and assuring that all performance, endurance, maintenance, safety and warning requirements of the application are met. The user must analyse all aspects of the application, follow applicable industry standards, and follow the information concerning the product in the current product catalogue and in any other materials provided from Parker or its subsidiaries or authorized distributors.

To the extent that Parker or its subsidiaries or authorized distributors provide component or system options based upon data or specifications provided by the user, the user is responsible for determining that such data and specifications are suitable and sufficient for all applications and reasonably foreseeable uses of the components or systems.

Offer of Sale

The items described in this document and other documents and descriptions provided by Parker Hannifin Corporation, its subsidiaries and its authorized distributors ("Seller") are hereby offered for sale at prices to be established by Seller. This offer and its acceptance by any customer ("Buyer") shall be governed by all of the following Terms and Conditions. Buyer's order for any item described in its document, when communicated to Seller verbally, or in writing, shall constitute acceptance of this offer. All goods or work described will be referred to as "Products".

1. Terms and Conditions. Seller's willingness to offer Products, or accept an order for Products, to or from Buyer is expressly conditioned on Buyer's assent to these Terms and Conditions and to the terms and conditions found on-line at www.parker.com/saleterms/. Seller objects to any contrary or additional term or condition of Buyer's order or any other document issued by Buyer.

2. Price Adjustments; Payments. Prices stated on the reverse side or preceding pages of this document are valid for 30 days. After 30 days, Seller may change prices to reflect any increase in its costs resulting from state, federal or local legislation, price increases from its suppliers, or any change in the rate, charge, or classification of any carrier. The prices stated on the reverse or preceding pages of this document do not include any sales, use, or other taxes unless so stated specifically. Unless otherwise specified by Seller, all prices are F.O.B. Seller's facility, and payment is due 30 days from the date of invoice. After 30 days, Buyer shall pay interest on any unpaid invoices at the rate of 1.5% per month or the maximum allowable rate under applicable law.

3. Delivery Dates; Title and Risk; Shipment. All delivery dates are approximate and Seller shall not be responsible for any damages resulting from any delay. Regardless of the manner of shipment, title to any products and risk of loss or damage shall pass to Buyer upon tender to the carrier at Seller's facility (i.e., when it's on the truck, it's yours). Unless otherwise stated, Seller may exercise its judgment in choosing the carrier and means of delivery. No deferral of shipment at Buyers' request beyond the respective dates indicated will be made except on terms that will indemnify, defend and hold Seller harmless against all loss and additional expense. Buyer shall be responsible for any additional shipping charges incurred by Seller due to Buyer's changes in shipping, product specifications or in accordance with Section 13, herein.

4. Warranty. Seller warrants that the Products sold hereunder shall be free from defects in material or workmanship for a period of twelve months from the date of delivery to Buyer or 2,000 hours of normal use, whichever occurs first. This warranty is made only to Buyer and does not extend to anyone to whom Products are sold after purchased from Seller. The prices charged for Seller's products are based upon the exclusive limited warranty stated above, and upon the following disclaimer: **DISCLAIMER OF WARRANTY: THIS WARRANTY COMPRISES THE SOLE AND ENTIRE WARRANTY PERTAINING TO PRODUCTS PROVIDED HEREUNDER. SELLER DISCLAIMS ALL OTHER WARRANTIES, EXPRESS AND IMPLIED, INCLUDING MERCHANTABILITY AND FITNESS FOR A PARTICULAR PURPOSE.**

5. Claims; Commencement of Actions. Buyer shall promptly inspect all Products upon delivery. No claims for shortages will be allowed unless reported to the Seller within 10 days of delivery.

No other claims against Seller will be allowed unless asserted in writing within 60 days after delivery or, in the case of an alleged breach of warranty, within 30 days after the date within the warranty period on which the defect is or should have been discovered by Buyer. Any action based upon breach of this agreement or upon any other claim arising out of this sale (other than an action by Seller for any amount due to Seller from Buyer) must be commenced within thirteen months from the date of tender of delivery by Seller or, for a cause of action based upon an alleged breach of warranty, within thirteen months from the date within the warranty period on which the defect is or should have been discovered by Buyer.

6. LIMITATION OF LIABILITY. UPON NOTIFICATION, SELLER WILL, AT ITS OPTION, REPAIR OR REPLACE A DEFECTIVE PRODUCT, OR REFUND THE PURCHASE PRICE. IN NO EVENT SHALL SELLER BE LIABLE TO BUYER FOR ANY SPECIAL, INDIRECT, INCIDENTAL OR CONSEQUENTIAL DAMAGES ARISING OUT OF, OR AS THE RESULT OF, THE SALE, DELIVERY, NON-DELIVERY, SERVICING, USE OR LOSS OF USE OF THE PRODUCTS OR ANY PART THEREOF, OR FOR ANY CHARGES OR EXPENSES OF ANY NATURE INCURRED WITHOUT SELLER'S WRITTEN CONSENT, EVEN IF SELLER HAS BEEN NEGLIGENT, WHETHER IN CONTRACT, TORT OR OTHER LEGAL THEORY. IN NO EVENT SHALL SELLER'S LIABILITY UNDER ANY CLAIM MADE BY BUYER EXCEED THE PURCHASE PRICE OF THE PRODUCTS.

7. Contingencies. Seller shall not be liable for any default or delay in performance if caused by circumstances beyond the reasonable control of Seller.

8. User Responsibility. The user, through its own analysis and testing, is solely responsible for making the final selection of the system and Product and assuring that all performance, endurance, maintenance, safety and warning requirements of the application are met. The user must analyze all aspects of the application and follow applicable industry standards and Product information. If Seller provides Product or system options, the user is responsible for determining that such data and specifications are suitable and sufficient for all applications and reasonably foreseeable uses of the Products or systems.

9. Loss to Buyer's Property. Any designs, tools, patterns, materials, drawings, confidential information or equipment furnished by Buyer or any other items which become Buyer's property, may be considered obsolete and may be destroyed by Seller after two consecutive years have elapsed without Buyer placing an order for the items which are manufactured using such property. Seller shall not be responsible for any loss or damage to such property while it is in Seller's possession or control.

10. Special Tooling. A tooling charge may be imposed for any special tooling, including without limitation, dies, fixtures, molds and patterns, acquired to manufacture Products.

Such special tooling shall be and remain Seller's property notwithstanding payment of any charges by Buyer. In no event will Buyer acquire any interest in apparatus belonging to Seller which is utilized in the manufacture of the Products, even if such apparatus has been specially converted or adapted for such manufacture and notwithstanding any charges paid by Buyer. Unless otherwise agreed, Seller shall have the right to alter, discard or otherwise dispose of any special tooling or other property in its sole discretion at any time.

11. Buyer's Obligation; Rights of Seller. To secure payment of all sums due or otherwise, Seller shall retain a security interest in the goods delivered and this agreement shall be deemed a Security Agreement under the Uniform Commercial Code. Buyer authorizes Seller as its attorney to execute and file on Buyer's behalf all documents Seller deems necessary to perfect its security interest. Seller shall have a security interest in, and lien upon, any property of Buyer in Seller's possession as security for the payment of any amounts owed to Seller by Buyer.

12. Improper use and Indemnity. Buyer shall indemnify, defend, and hold Seller harmless from any claim, liability, damages, lawsuits, and costs (including attorney fees), whether for personal injury, property damage, patent, trademark or copyright infringement or any other claim, brought by or incurred by Buyer, Buyer's employees, or any other person, arising out of: (a) improper selection, improper application or other misuse of Products purchased by Buyer from Seller; (b) any act or omission, negligent or otherwise, of Buyer; (c) Seller's use of patterns, plans, drawings, or specifications furnished by Buyer to manufacture Product; or (d) Buyer's failure to comply with these terms and conditions. Seller shall not indemnify Buyer under any circumstance except as otherwise provided.

13. Cancellations and Changes. Orders shall not be subject to cancellation or change by Buyer for any reason, except with Seller's written consent and upon terms that will indemnify, defend and hold Seller harmless against all direct, incidental and consequential loss or damage. Seller may change product features, specifications, designs and availability with notice to Buyer.

14. Limitation on Assignment. Buyer may not assign its rights or obligations under this agreement without the prior written consent of Seller.

15. Entire Agreement. This agreement contains the entire agreement between the Buyer and Seller and constitutes the final, complete and exclusive expression of the terms of the agreement. All prior or contemporaneous written or oral agreements or negotiations with respect to the subject matter are herein merged.

16. Waiver and Severability. Failure to enforce any provision of this agreement will not waive that provision nor will any such failure prejudice Seller's right to enforce that provision in the future. Invalidation of any provision of this agreement by legislation or other rule of law shall not invalidate any other provision herein. The remaining provisions of this agreement will remain in full force and effect.

17. Termination. This agreement may be terminated by Seller for any reason and at any time by giving Buyer thirty

(30) days written notice of termination. In addition, Seller may by written notice immediately terminate this agreement for the following: (a) Buyer commits a breach of any provision of this agreement (b) the appointment of a trustee, receiver or custodian for all or any part of Buyer's property (c) the filing of a petition for relief in bankruptcy of the other Party on its own behalf, or by a third party (d) an assignment for the benefit of creditors, or (e) the dissolution or liquidation of the Buyer.

18. Governing Law. This agreement and the sale and delivery of all Products hereunder shall be deemed to have taken place in and shall be governed and construed in accordance with the laws of the State of Ohio, as applicable to contracts executed and wholly performed therein and without regard to conflicts of laws principles. Buyer irrevocably agrees and consents to the exclusive jurisdiction and venue of the courts of Cuyahoga County, Ohio with respect to any dispute, controversy or claim arising out of or relating to this agreement. Disputes between the parties shall not be settled by arbitration unless, after a dispute has arisen, both parties expressly agree in writing to arbitrate the dispute.

19. Indemnity for Infringement of Intellectual Property Rights. Seller shall have no liability for infringement of any patents, trademarks, copyrights, trade dress, trade secrets or similar rights except as provided in this Section. Seller will defend and indemnify Buyer against allegations of infringement of U.S. patents, U.S. trademarks, copyrights, trade dress and trade secrets ("Intellectual Property Rights"). Seller will defend at its expense and will pay the cost of any settlement or damages awarded in an action brought against Buyer based on an allegation that a Product sold pursuant to this Agreement infringes the Intellectual Property Rights of a third party. Seller's obligation to defend and indemnify Buyer is contingent on Buyer notifying Seller within ten (10) days after Buyer becomes aware of such allegations of infringement, and Seller having sole control over the defense of any allegations or actions including all negotiations for settlement or compromise. If a Product is subject to a claim that it infringes the Intellectual Property Rights of a third party, Seller may, at its sole expense and option, procure for Buyer the right to continue using the Product, replace or modify the Product so as to make it noninfringing, or offer to accept return of the Product and return the purchase price less a reasonable allowance for depreciation. Notwithstanding the foregoing, Seller shall have no liability for claims of infringement based on information provided by Buyer, or directed to Products delivered hereunder for which the designs are specified in whole or part by Buyer, or infringements resulting from the modification, combination or use in a system of any Product sold hereunder. The foregoing provisions of this Section shall constitute Seller's sole and exclusive liability and Buyer's sole and exclusive remedy for infringement of Intellectual Property Rights.

20. Taxes. Unless otherwise indicated, all prices and charges are exclusive of excise, sales, use, property, occupational or like taxes which may be imposed by any taxing authority upon the manufacture, sale or delivery of Products.

21. Equal Opportunity Clause. For the performance of government contracts and where dollar value of the Products exceed \$10,000, the equal employment opportunity clauses in Executive Order 11246, VEVRAA, and 41 C.F.R. §§ 60-1.4(a), 60-741.5(a), and 60-250.4, are hereby incorporated.

Index

A

Accessories 61, 62
Adaptor, Lapped Joint 69
Adaptors, Kidney, Oval, Flanges 11, 63
Angle pattern 22
ANSI B31.1 15
Anti-tamper 19
Assembly and Test of Free Issue Instrument 71

B

Base Connected Manifolds 50, 52
Base enclosure 51
Baumer Safety Pressure Gauges 70
Best Available Technique (BAT) 17
Bonnet design 13
 Fire safe 15
 Larger bore 14
 Low emission 17
 Power plant 15
 Rising plug 16
 Soft seat tip 14
 Standard 13
Brackets
 For remote mount manifolds 34, 40
 For direct mount manifolds 48, 49, 60

C

CCIMS 65
Check Valves - Hi-Check Series 64
Codes 6
Condensate Pots 65
Connections 8, 9, 10, 11, 12
Coplanar 55, 58, 60

D

DIN EN 61518 12
Direct mount 41, 42, 44, 46
Distribution Manifolds 65, 68, 69

E

Emerson 55
Enclosure 50, 52, 54

F

Fire safe 15
Flange Connector, Flange to Parker tube fitting 69
Flange Connections, Kidney, Oval Adaptors 11, 63
Free Issue Instrument, Assembly and Test 71

G

Gauge Syphon 61
Gauge Valves
 Multi-port - HGV, HGWWG Series 24
 Single block - HNVV Series 23
Gauges 70

H

HAL Series 30
Hand Valves
 Angle pattern - HNAV Series 22
 Straight pattern - HNV Series 21
Handwheel 19
HD Series 41, 42, 44, 51, 56
HEH Series 45
HET Series 45
HGV Series 24
HGWWG Series 24
HLLHV Series 31
HL Series 30, 31, 36, 50
HLTF Series 30
HLWG Series 31
HNAV Series 22
HNL Series 29
HNV Series 21
HNVV Series 23
HRPV Series 25

I

IEC 61518 12
Integral tubing connections 8, 9
Instrument, Free Issue, Assembly, Test 71
ISO 15848 17

K

Key 19
Kidney Flanges 11, 63

L

Lapped Joint Tube Adaptor 69
Large Bore Needle Valves 64
Larger bore 14
Long pattern 29
Low emission 17, 18

M

Manifolds
 2-valve - Direct Mount 41
 2-valve - Remote/Line Mount - long pattern - HNL Series 29
 2-valve - Remote/Line Mount - short pattern 30
 3-valve - Direct mount 42
 3-valve - Remote/Line Mount 36
 5-valve - Direct Mount 44
 5-valve - Remote/Line Mount 37
 Base Connected For Enclosure Mounting 50, 51
 Manifolds for 2051/3051 Coplanar Transmitters 55, 56, 57
Materials of construction 6, 7
Monoflange 68
Multi-port gauge valves 24

O

Oval Flanges 11, 63

P

Panel mounting 19
Parallel Pipe Threads 11
Plug 61
Power plant 15
Pro-Bloc 68
Proportional Relief Valves - HPRV Series 64
PTFree connect 10

R

Remote/line mount 29, 30, 31, 32, 36, 37, 38
Rising Plug Valves - HRPV Series 25
Rosemount 55

S

Shell 66
Short pattern 30
Soft seat tip 14
Standards 6
Swivel gauge adaptor 24, 31, 50, 62

T

TA-Luft 17
Tapered Pipe Threads 11
T bar handle locking 19
Test, Free Issue Instrument 71
Total 67
Transmitter flange connections 12
Transmitter interface 51
Tru-Loc 16
Type A 12
Type B 12

U

U bolt 34, 40, 48

W

Weld Connections 11

Parker Worldwide

Europe, Middle East, Africa

AE – United Arab Emirates,

Dubai

Tel: +971 4 8127100

AT – Austria, St. Florian

Tel: +43 (0)7224 66201

AZ – Azerbaijan, Baku

Tel: +994 50 2233 458

BE/NL/LU – Benelux,

Hendrik Ido Ambacht

Tel: +31 (0)541 585 000

BY – Belarus, Minsk

Tel: +48 (0)22 573 24 00

CH – Switzerland, Etoy

Tel: +41 (0)21 821 87 00

CZ – Czech Republic,

Prague

Tel: +420 284 083 111

DE – Germany, Kaarst

Tel: +49 (0)2131 4016 0

DK – Denmark, Ballerup

Tel: +45 43 56 04 00

ES – Spain, Madrid

Tel: +34 902 330 001

FI – Finland, Vantaa

Tel: +358 (0)20 753 2500

FR – France, Contamine s/Arve

Tel: +33 (0)4 50 25 80 25

GR – Greece

Tel: +30 69 44 52 78 25

HU – Hungary, Budaörs

Tel: +36 23 885 470

IE – Ireland, Dublin

Tel: +353 (0)1 466 6370

IL – Israel

Tel: +39 02 45 19 21

IT – Italy, Corsico (MI)

Tel: +39 02 45 19 21

KZ – Kazakhstan, Almaty

Tel: +7 7273 561 000

NO – Norway, Asker

Tel: +47 66 75 34 00

PL – Poland, Warsaw

Tel: +48 (0)22 573 24 00

PT – Portugal

Tel: +351 22 999 7360

RO – Romania, Bucharest

Tel: +40 21 252 1382

SE – Sweden, Borås

Tel: +46 (0)8 59 79 50 00

SL – Slovenia, Novo Mesto

Tel: +386 7 337 6650

TR – Turkey, Istanbul

Tel: +90 216 4997081

UK – United Kingdom, Warwick

Tel: +44 (0)1926 317 878

ZA – South Africa, Kempton Park

Tel: +27 (0)11 961 0700

North America

CA – Canada, Milton, Ontario

Tel: +1 905 693 3000

US – USA, Cleveland

Tel: +1 216 896 3000

Asia Pacific

AU – Australia, Castle Hill

Tel: +61 (0)2-9634 7777

CN – China, Shanghai

Tel: +86 21 2899 5000

HK – Hong Kong

Tel: +852 2428 8008

IN – India, Mumbai

Tel: +91 22 6513 7081-85

JP – Japan, Tokyo

Tel: +81 (0)3 6408 3901

KR – South Korea, Seoul

Tel: +82 2 559 0400

MY – Malaysia, Shah Alam

Tel: +60 3 7849 0800

NZ – New Zealand, Mt Wellington

Tel: +64 9 574 1744

SG – Singapore

Tel: +65 6887 6300

TH – Thailand, Bangkok

Tel: +662 186 7000

TW – Taiwan, Taipei

Tel: +886 2 2298 8987

South America

AR – Argentina, Buenos Aires

Tel: +54 3327 44 4129

BR – Brazil, Sao Jose dos Campos

Tel: +55 080 0727 5374

CL – Chile, Santiago

Tel: +56 22 303 9640

MX – Mexico, Toluca

Tel: +52 72 2275 4200

European Product Information Centre

Free phone: 00 800 27 27 5374

(from AT, BE, CH, CZ, DE, DK, EE, ES, FI, FR, IE, IL, IS, IT, LU, MT, NL, NO, PL, PT, RU, SE, SK, UK, ZA)



Parker Hannifin Manufacturing Ltd.
Instrumentation Products Division, Europe
Riverside Road
Barnstaple EX31 1NP
United Kingdom

phone 0044 (0)1271 313131
www.parker.com/ipd